



HEPP



COLLECTION

Glanzstücke für die Tafelkultur und professionelles Equipment

HEPP zählt zu den bedeutendsten Anbietern rund um den gedeckten Tisch und ist Marktführer in Bezug auf Angebotsvielfalt. In einer hochmodernen Fertigung für Tafel- und Serviergeräte werden hunderte von Artikeln hergestellt: Vom Besteck über Kaffeekännchen bis hin zu Chafing-Dishes und Speisenverteilssysteme. Ein etabliertes Vertriebs-Partnernetz sorgt für professionelle Beratung rund um den Globus.

Seit 1863 hat sich HEPP einen Namen in der gehobenen Gastronomie und Hotellerie gemacht. Der Erfolg setzt sich – damals wie heute – aus traditionellen Werten wie Zuverlässigkeit und Qualität, sowie Innovationskraft und Flexibilität zusammen.

Showpieces for fine dining and professional equipment

HEPP ranks among the most important suppliers in the field of tableware and is the market leader with regard to its wide range of products. In a highly modern production line for hollowware and flatware hundreds of articles are manufactured: From cutlery through coffee jugs to chafing dishes and food distribution systems. An established distribution and partner network ensures professional advice around the globe. Since 1863 HEPP has made their name in the upmarket catering and hotel business.

The success – then as now – is founded on traditional values such as reliability and quality, as well as innovative drive and flexibility.



Für die besten Adressen der Welt

For the best locations worldwide



HEPP-Produkte sorgen für gepflegte Gastlichkeit bei Kunden in über 90 Ländern rund um den Globus. Darunter finden sich Top-Namen aus der Hotel- und Gastronomiewelt. Zu ihnen zählen neben dem in Deutschland bekannten Hotel Adlon in Berlin auch die über 70 Fünf-Sterne-Hotels der Ritz-Carlton-Gruppe (USA), sowie namhafte High Class-Hotels weltweit.

HEPP products provide sophisticated hospitality in over 90 countries throughout the world. They include top names from the world of catering. Among them rank, alongside Hotel Adlon in Berlin, a famous hotel in Germany, 70 five star hotels of the Ritz-Carlton Group (USA), as well as high class hotels worldwide.



Airlines



First-Class Hotels



Cruise Lines

Mit stilvollen Kollektionen stimmungsvoll eindecken

Die Kollektionen von HEPP werden als Kreativkomponenten für die Tischkultur entwickelt.

Ob für Bar, Buffet oder den gedeckten Tisch, neben sämtlichen Basisteilen bieten die HEPP-Kollektionen auch Accessoires für die Erfordernisse einer großen Tafel. Auffälligstes Gestaltungsmerkmal sind die designten Griffe, Knöpfe und Füße – die prägnante Formgebung der Kollektionen spiegelt sich in allen Teilen wieder. Bei jeder Kollektion unterstreichen konsequente Linienführung und funktionelle Details die exklusive und moderne Eleganz.

Creating mood with stylish collections

The collections from HEPP have been developed as creative components for fine dining culture.

Whether for the bar, buffet or a table setting, the HEPP collections also provide accessories for the requirements of a large table, besides the complete basic pieces. The most striking design characteristics are the designed handles, knobs and feet – the remarkable shapes of the extraordinary collections are reflected in all the pieces. In each collection the consistent use of lines and functional details emphasize the exclusive and modern elegance.



Tradition



Arte



Profile



Excellent



Exclusive

Zeitlos schönes Design

Timeless, beautiful design

Design, Qualität und Individualisierung

Gebrüder HEPP versteht sich als Anbieter von Markenprodukten, die in Gestaltung, Qualität und Gebrauchsnutzen höchsten Ansprüchen gerecht werden. Von der Idee bis zum fertigen Produkt und im täglichen Gastronomieinsatz – Material und Verarbeitung stehen im Vordergrund. Als Erfinder des Hotelsilbers stützt sich die Marke HEPP auf diese Grundsätze. Die zeitlos schönen Tafelgeräte werden von HEPP auch nach Ihren Wünschen veredelt und individuell gestaltet.

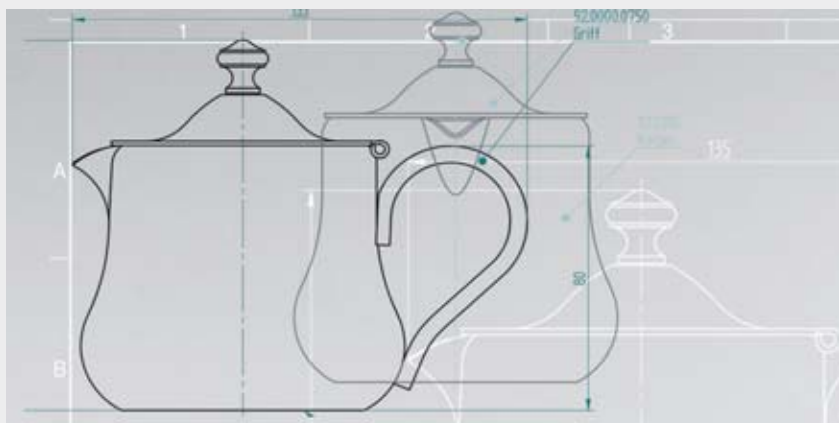

Design, Quality and Customizing

Gebrüder HEPP regards itself as suppliers of brand products that meet the highest demands of design, quality and product use. From the conception to the finished product and in day-to-day handling in catering – the focus is on the material and workmanship. As the inventor of hotel silverware, the brand HEPP is based on these principles. According to your wishes the timeless table appliances are refined and customized by HEPP – for example by customizing your flatware with an engraving or stamp.



HEPP eine Marke als Erlebnis

Das klassisch Schöne verführt den Kenner und Genießer. Deshalb bietet HEPP als international führender Anbieter eine große Sortimentsvielfalt. Sie zeichnet sich aus durch souverän, zeitlose Formen und modern, avantgardistisches Design.

HEPP a brand as an experience

Classic beauty attracts connoisseurs and gourmets. This is why HEPP, as the leading supplier of cutlery, serving articles and airlines-inflight items on the international market has a particularly extensive range of products, as well as great diversity. It ranges from cutlery with a high quality of workmanship and serving articles with competent, timeless shapes to modern, avantgarde design.



Inhalt · Content



Besteck
Cutlery

Frühstück
Breakfast

Menü & Bankett
Menu & Banquet

Chafing Dish
& Buffet

Bar

Servierwagen
Serving trolley

Pflege
Maintenance

Index A-Z



Stilvolle Gastlichkeit beginnt beim Besteck

Besteck ist schon seit Menschengedenken mehr als ein rein nützliches Tafelgerät. Es ist die optische und haptische Ausdrucksform von Kultur und Lebensart. Deshalb bietet HEPP Produktvielfalt – ein breites Spektrum an Designs und Stilrichtungen. Überzeugen Sie sich von der Auswahl aus hochwertigsten Materialien in Edelstahl 18/10, 18/0 und in der versilberten Ausführung.

Stylish hospitality starts with cutlery

Since time immemorial cutlery has been more than simply a useful table utensil. It is the visual and tactile expression of culture and lifestyle. Which is why HEPP is offering a diverse product range: a wide choice of designs and styles. Take a look at our choice of the finest materials in 18/10 stainless steel, 18/0 and in a silver-plated finish.





BESTECK · CUTLERY



Das avantgardistische Besteckmodell EMOTION verführt durch eine dynamische Silhouette und die schmeichelnde Haptik – sinnlich in der Linienführung und dabei souverän in Design und Material.

The appeal of the avantgarde collection EMOTION lies in the dynamic silhouette and flattering tactile quality – a sensual use of lines and at the same time confident in design and material.

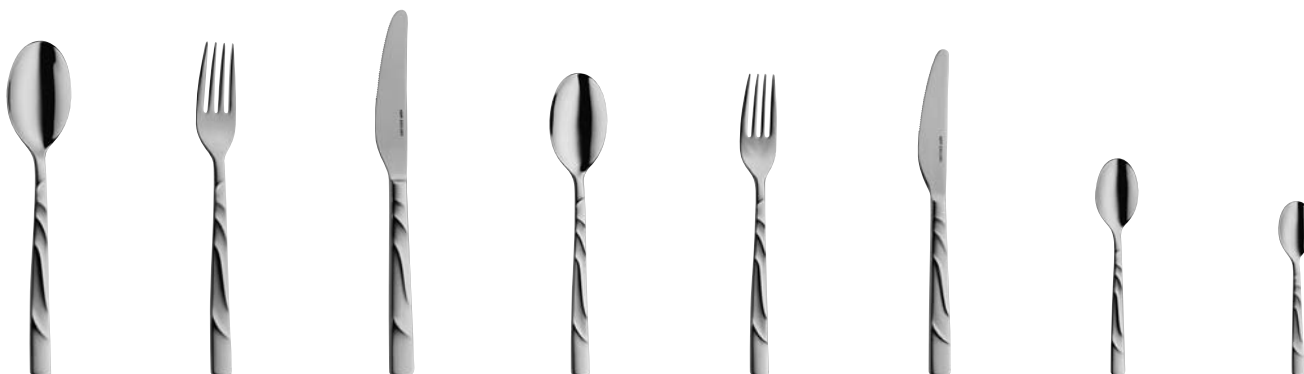

.1010
Esslöffel
Table spoon
212 mm · 8³/₈ in.

.1020
Essgabel
Table fork
210 mm · 8¹/₄ in.

.1800
Tafelmesser
Table knife
234 mm · 9³/₁₆ in.

.1050
Dessertlöffel
Dessert spoon
190 mm · 7¹/₂ in.

.1060
Dessertgabel
Dessert fork
188 mm · 7⁵/₈ in.

.1810
Dessertmesser
Dessert knife
210 mm · 8¹/₄ in.

.1100
Kaffeelöffel
Coffee spoon
136 mm · 5³/₈ in.

.1110
Moccalöffel
Demi-tasse spoon
110 mm · 4⁵/₁₆ in.



.1140
Fischmesser
Fish knife
208 mm · 8³/₁₆ in.

.1150
Fischgabel
Fish fork
184 mm · 7¹/₄ in.

.1210
Limonadenlöffel
Iced tea spoon
220 mm · 8¹¹/₁₆ in.

.1330
Buttermesser²⁾
Butter knife
170 mm · 6¹¹/₁₆ in.

.1580
Franz. Saucenlöffel
French sauce spoon
195 mm · 7¹¹/₁₆ in.

.1630
Runder Suppenlöffel
Round soup spoon
176 mm · 6¹⁵/₁₆ in.

.1750
Nachspeisegabel
Dessert fork
160 mm · 6⁵/₁₆ in.

.1950
Steakmesser
Steak knife
239 mm · 9⁷/₁₆ in.

Besteck-Einzelteile
Serving pieces

18/10
18/10
versilbert
silver plated

01.0054 03.0154

¹⁾ Hohlheft (18/10)
hollow handle (18/10)

²⁾ ohne Wellenschliff
without serrated blade

EMOTION



Profilieren Sie sich als Gastgeber mit dem Besteckmodell, dessen Messer sich raffiniert auch im Stehen eindecken lässt. PROFILE fällt trotz seiner Sachlichkeit und geometrischer Formstrenge auf.

Shine as host with the cutlery model with the knives that ingeniously can also be placed on the blade. PROFILE is striking even with its functional appearance and strict geometric shape.



.1010
Esslöffel
Table spoon
206 mm · 8¹/₁₆ in.



.1020
Essgabel
Table fork
208 mm · 8³/₁₆ in.



.1800
Tafelmesser
Table knife
230 mm · 9¹/₁₆ in.



.1980
Tafelmesser³⁾
Table knife
230 mm · 9¹/₁₆ in.



.1050
Dessertlöffel
Dessert spoon
183 mm · 7³/₁₆ in.



.1060
Dessertgabel
Dessert fork
185 mm · 7⁵/₁₆ in.



.1810
Dessertmesser
Dessert knife
202 mm · 7¹⁵/₁₆ in.



.1990
Dessertmesser³⁾
Dessert knife
202 mm · 7¹⁵/₁₆ in.



.1100
Kaffeelöffel
Coffee spoon
140 mm · 5¹/₂ in.



.1110
Moccalöffel
Demi-tasse spoon
110 mm · 4³/₁₆ in.



.1140
Fischmesser
Fish knife
205 mm · 8¹/₁₆ in.



.1150
Fischgabel
Fish fork
185 mm · 7⁵/₁₆ in.



.1210
Limonadenlöffel
Iced tea spoon
193 mm · 7⁷/₁₆ in.



.1270
Universal-Löffel-Gabel
Comb. Spoon-Fork
184 mm · 7³/₁₆ in.



.1330
Buttermesser²⁾
Butter knife
170 mm · 6¹¹/₁₆ in.



.1580
Franz. Saucenlöffel
French sauce spoon
182 mm · 7³/₁₆ in.



.1630
Runder Suppenlöffel
Round soup spoon
182 mm · 7³/₁₆ in.



.1740
Nachspeiselöffel
Dessert spoon
145 mm · 6¹/₁₆ in.



.1750
Nachspeisegabel
Dessert fork
155 mm · 6¹/₈ in.



.1890
Buttermesser²⁾
Butter knife
165 mm · 6¹/₂ in.



.1950
Steakmesser
Steak knife
234 mm · 9³/₁₆ in.

Besteck-Einzelteile
Serving pieces

18/10
18/10

versilbert
silver plated

rostfreier Stahl
stainless steel

01.0048

03.0148

06.0048³⁾

¹⁾ Hohlheft (18/10)
hollow handle (18/10)

²⁾ ohne Wellenschliff
without serrated blade

³⁾ Designvariante
alternative design

PROFILE



BAGUETTE ist ein Besteck von zeitloser Eleganz und vermittelt ein sinnliches Erlebnis des Wohlbefindens zu Tisch. Die Ausgewogenheit des Designs und die elegante Linie dieses Besteckklassikers überzeugen.

BAGUETTE is cutlery of timeless elegance, conveying a pleasurable feeling of well being at table. The appeal of this classic cutlery lies in the harmony of the design and the elegant lines.



.1010
Esslöffel
Table spoon
205 mm · 8 1/16 in.



.1020
Essgabel
Table fork
206 mm · 8 1/8 in.



.1910
Essgabel
Table fork
203 mm · 8 in.



.1710
Menügabel
Table fork
195 mm · 7 7/16 in.



.1030
Tafelmesser¹⁾
Table knife
245 mm · 9 3/4 in.



.1800
Tafelmesser
Table knife
240 mm · 9 7/16 in.



.1050
Dessertlöffel
Dessert spoon
180 mm · 7 1/16 in.



.1060
Dessertgabel
Dessert fork
182 mm · 7 3/16 in.



.1920
Dessertgabel
Dessert fork
185 mm · 7 3/16 in.



.1070
Dessertmesser¹⁾
Dessert knife
211 mm · 8 5/16 in.



.1810
Dessertmesser
Dessert knife
212 mm · 8 5/8 in.



.1100
Kaffeelöffel
Coffee spoon
135 mm · 5 5/16 in.



.1110
Moccalöffel
Demi-tasse spoon
111 mm · 4 3/8 in.



.1120
Kuchengabel
Cake fork
155 mm · 6 1/8 in.



.1140
Fischmesser
Fish knife
198 mm · 7 13/16 in.



.1150
Fischgabel
Fish fork
179 mm · 7 1/16 in.



.1180
Consommelöffel
Bouillon spoon
160 mm · 6 5/16 in.



.1210
Limonadenlöffel
Iced tea spoon
223 mm · 8 3/4 in.



.1330
Buttermesser²⁾
Butter knife
170 mm · 6 11/16 in.



.1500
Tranchiermesser
Carving knife
250 mm · 9 13/16 in.



.1510
Tranchiergabel
Carving fork
225 mm · 8 7/8 in.



.1550
Steakmesser¹⁾
Steak knife
230 mm · 9 1/16 in.



.1580
Franz. Saucenlöffel
French sauce spoon
181 mm · 7 1/8 in.



.1630
Runder Suppenlöffel
Round soup spoon
180 mm · 7 1/16 in.



.1720
Menümesser¹⁾
Table knife
222 mm · 8 3/4 in.



.1820
Menümesser
Table knife
223 mm · 8 3/4 in.



.1830
Tafelmesser
Table knife
240 mm · 9 7/16 in.



.1850
Dessertmesser
Dessert knife
212 mm · 8 5/8 in.



.1860
Buttermesser
Butter knife
165 mm · 6 1/2 in.

Besteck-Einzelteile
Serving pieces

18/10
18/10
versilbert
silver plated

01.0032 03.0132

¹⁾ Hohlheft (18/10)
hollow handle (18/10)

²⁾ ohne Wellenschliff
without serrated blade

BAGUETTE



Lebensfroh, unkompliziert und mit schwungvoller Linie präsentiert sich die Besteckserie CARLTON dort, wo sich Gäste an der anspruchsvollen Tafel zusammenfinden.

Joyful, uncomplicated and with sweeping lines, CARLTON is the favourite where guests gather at sophisticated, gourmet dining tables.

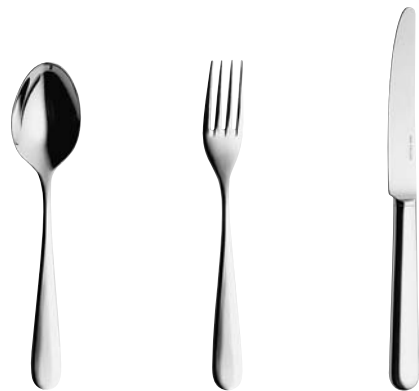

.1010
Esslöffel
Table spoon
205 mm · 8¹/₁₆ in.

.1020
Essgabel
Table fork
201 mm · 7⁵/₁₆ in.

.1030
Tafelmesser¹⁾
Table knife
237 mm · 9⁵/₁₆ in.



.1800
Tafelmesser
Table knife
237 mm · 9⁵/₁₆ in.

.1050
Dessertlöffel
Dessert spoon
180 mm · 7¹/₁₆ in.

.1060
Dessertgabel
Dessert fork
180 mm · 7¹/₁₆ in.

.1070
Dessertmesser¹⁾
Dessert knife
210 mm · 8¹/₄ in.

.1810
Dessertmesser
Dessert knife
215 mm · 8⁷/₁₆ in.

.1100
Kaffeelöffel
Coffee spoon
140 mm · 5¹/₂ in.

.1110
Moccalöffel
Demi-tasse spoon
110 mm · 4³/₁₆ in.

.1120
Kuchengabel
Cake fork
155 mm · 6¹/₈ in.

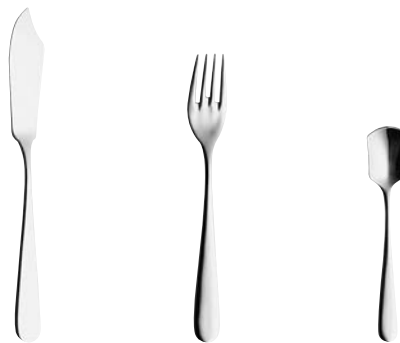

.1140
Fischmesser
Fish knife
200 mm · 7⁷/₈ in.

.1150
Fischgabel
Fish fork
175 mm · 6⁷/₈ in.

.1190
Eisschaufel
Ice shovel
131 mm · 5³/₁₆ in.



.1210
Limonadenlöffel
Iced tea spoon
190 mm · 7¹/₂ in.

.1220
Austerngabel
Oyster fork
130 mm · 5¹/₈ in.

.1260
Schneckengabel
Snail fork
145 mm · 5¹¹/₁₆ in.

.1300
Dressinglöffel
Dressing spoon
280 mm · 11 in.

.1330
Buttermesser²⁾
Butter knife
170 mm · 6¹¹/₁₆ in.

.1340
Gemüselöffel
Vegetable spoon
203 mm · 8 in.

.1370
Saucenlöffel
Sauce spoon
180 mm · 7¹/₁₆ in.

.1400
Suppenschöpfer
Soup ladle large,
252 mm · 9⁹/₁₆ in.



.1410
Portionsschöpfer
Soup ladle small,
206 mm · 8¹/₈ in.

.1420
Tortenheber
Cake server
225 mm · 8⁷/₈ in.

.1450
Vorlegegabel
Serving fork
193 mm · 7⁵/₈ in.



.1470
Vorlegelöffel
Serving spoon
280 mm · 11 in.

.1480
Vorlegegabel
Serving fork
280 mm · 11 in.

.1540
Grapefrüttlöffel
Grapefruit spoon
146 mm · 5³/₄ in.

.1550
Steakmesser¹⁾
Steak knife
230 mm · 9¹/₁₆ in.

.1950
Steakmesser
Steak knife
230 mm · 9¹/₁₆ in.

.1560
Servierlöffel
Serving spoon
228 mm · 9 in.

.1570
Serviergabel
Serving fork
227 mm · 8¹⁵/₁₆ in.

.1580
Franz. Saucenlöffel
French sauce spoon
185 mm · 7⁵/₁₆ in.

.1630
Runder Suppenlöffel
Round soup spoon
175 mm · 6⁷/₈ in.

Besteck-Einzelteile
Serving pieces

18/10
18/10

versilbert
silver plated

01.0045 03.0145

¹⁾ Hohlheft (18/10)
hollow handle (18/10)

²⁾ ohne Wellenschliff
without serrated blade

CARLTON



Die weiche, Kontur verstärkende Formgebung vereint mit einer fließenden Linienführung, erzeugt bei der Besteckserie CONTOUR eine schlichte Ästhetik, die sich für edlen Anlass und Ambiente anbietet.

The design, intensified by the soft contours and flowing lines creates the unpretentious aesthetics of the CONTOUR cutlery range that lends itself to grand occasions and ambience.



.1010 Esslöffel Table spoon 202 mm · 7 ¹⁵ / ₁₆ in.	.1020 Essgabel Table fork 205 mm · 8 ¹ / ₁₆ in.	.1030 Tafelmesser¹⁾ Table knife 226 mm · 8 ⁷ / ₈ in.	.1800 Tafelmesser Table knife 226 mm · 8 ⁷ / ₈ in.	.1830 Tafelmesser Table knife 226 mm · 8 ⁷ / ₈ in.	.1050 Dessertlöffel Dessert spoon 177 mm · 6 ¹⁵ / ₁₆ in.	.1060 Dessertgabel Dessert fork 178 mm · 7 in.	.1070 Dessertmesser¹⁾ Dessert knife 206 mm · 8 ¹ / ₈ in.
---	--	--	---	---	---	---	--

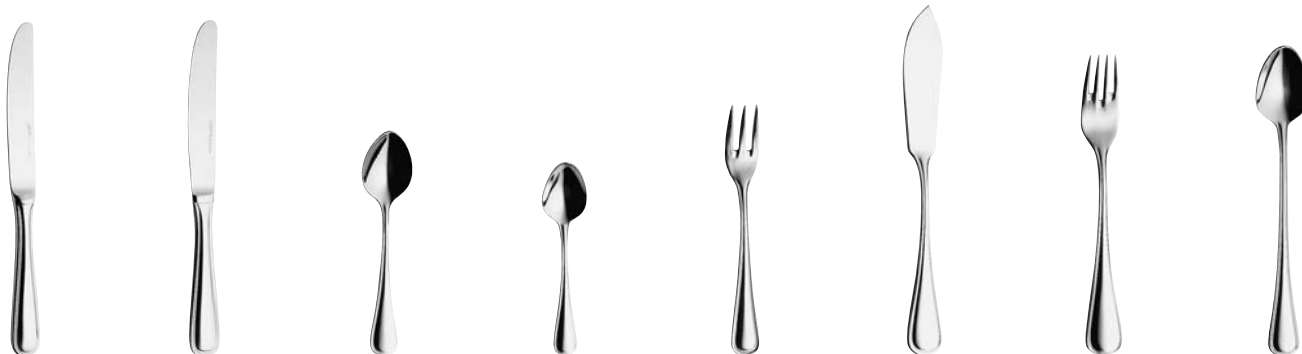

.1810 Dessertmesser Dessert knife 206 mm · 8 ¹ / ₈ in.	.1850 Dessertmesser Dessert knife 206 mm · 8 ¹ / ₈ in.	.1100 Kaffeelöffel Coffee spoon 138 mm · 5 ⁷ / ₁₆ in.	.1110 Moccalöffel Demi-tasse spoon 118 mm · 4 ⁵ / ₈ in.	.1130 Kuchengabel Cake fork 153 mm · 6 in.	.1140 Fischmesser Fish knife 214 mm · 8 ⁷ / ₁₆ in.	.1150 Fischgabel Fish fork 175 mm · 6 ⁷ / ₈ in.	.1210 Limonadenlöffel Iced tea spoon 181 mm · 7 ¹ / ₈ in.
---	---	--	--	---	---	--	--



.1330 Buttermesser²⁾ Butter knife 170 mm · 6 ¹¹ / ₁₆ in.	.1860 Buttermesser Butter knife 165 mm · 6 ¹ / ₂ in.	.1550 Steakmesser¹⁾ Steak knife 230 mm · 9 ¹ / ₁₆ in.	.1580 Franz. Saucenlöffel French sauce spoon 185 mm · 7 ⁵ / ₁₆ in.	.1630 Runder Suppenlöffel Round soup spoon 172 mm · 6 ³ / ₄ in.
--	---	---	---	--

Besteck-Einzelteile
Serving pieces

18/10
18/10

versilbert
silver plated

rostfreier Stahl
stainless steel

rostfreier Stahl versilbert
stainless steel silver plated

01.0036

03.0136

06.0036

08.0136

¹⁾ Hohlheft (18/10)
hollow handle (18/10)

²⁾ ohne Wellenschliff
without serrated blade

CONTOUR



Die Kollektion AURA mit sinnlicher Ausstrahlung steht für Eleganz und gefühlsbetonte Porzellanformen. Die weichen Linien formen ein handschmeichelndes Besteck mit einzigartiger Haptik.

The AURA model with luxurious charm represents elegance and organically-shaped china. The soft lines give the cutlery its original tactile quality that flatters the hand.



.1010
Esslöffel
Table spoon
211 mm · 8³/₁₆ in.



.1020
Essgabel
Table fork
210 mm · 8¹/₄ in.



.1800
Tafelmesser
Table knife
239 mm · 9⁷/₁₆ in.



.1980
Tafelmesser
Table knife
240 mm · 9⁷/₁₆ in.



.1050
Dessertlöffel
Dessert spoon
186 mm · 7⁵/₁₆ in.



.1060
Dessertgabel
Dessert fork
183 mm · 7³/₁₆ in.



.1810
Dessertmesser
Dessert knife
201 mm · 7¹⁵/₁₆ in.



.1990
Dessertmesser
Dessert knife
201 mm · 7¹⁵/₁₆ in.



.1100
Kaffeelöffel
Coffee spoon
142 mm · 5⁵/₁₆ in.



.1110
Moccalöffel
Demi-tasse spoon
114 mm · 4¹/₂ in.



.1750
Nachspeisegabel
Dessert fork
151 mm · 5⁵/₁₆ in.



.1140
Fischmesser
Fish knife
204 mm · 8¹/₁₆ in.



.1150
Fischgabel
Fish fork
180 mm · 7¹/₁₆ in.



.1210
Limonadenlöffel
Iced tea spoon
191 mm · 7¹/₂ in.



.1330
Buttermesser²⁾
Butter knife
170 mm · 6¹¹/₁₆ in.



.1890
Buttermesser²⁾
Butter knife
170 mm · 6¹¹/₁₆ in.



.1580
Franz. Saucenlöffel
French sauce spoon
185 mm · 7⁵/₁₆ in.



.1630
Runder Suppenlöffel
Round soup spoon
180 mm · 7¹/₁₆ in.



.1950
Steakmesser
Steak knife
223 mm · 9⁷/₁₆ in.



.1970
Steakmesser
Steak knife
239 mm · 9⁷/₁₆ in.

Besteck-Einzelteile
Serving pieces

18/10 versilbert
18/10 silver plated

01.0050 03.0150

¹⁾ Hohlheft (18/10)
hollow handle (18/10)

²⁾ ohne Wellenschliff
without serrated blade

AURA



Klassisches Design und gastronomische Eigenschaften mit vielseitigem Charakter. Die S-Shape Messer von ROYAL setzen interessante Akzente auf dem gedeckten Tisch.

Classic design and versatile culinary attributes – the S-shaped knives of ROYAL add interesting highlights to the table setting.



.1010
Esslöffel
Table spoon
207 mm · 8¹/₁₆ in.



.1020
Essgabel
Table fork
208 mm · 8³/₁₆ in.



.1800
Tafelmesser
Table knife
237 mm · 9⁵/₁₆ in.



.1980
Tafelmesser
Table knife
240 mm · 9⁷/₁₆ in.



.1050
Dessertlöffel
Dessert spoon
182 mm · 7³/₁₆ in.



.1060
Dessertgabel
Dessert fork
180 mm · 7¹/₁₆ in.



.1810
Dessertmesser
Dessert knife
206 mm · 8²/₁₆ in.



.1990
Dessertmesser
Dessert knife
202 mm · 7¹⁵/₁₆ in.



.1090
Kaffeelöffel
Coffee spoon
148 mm · 5¹³/₁₆ in.



.1110
Moccalöffel
Demi-tasse spoon
115 mm · 4⁹/₁₆ in.



.1750
Nachspeisegabel
Dessert fork
153 mm · 6 in.



.1140
Fischmesser
Fish knife
203 mm · 8 in.



.1150
Fischgabel
Fish fork
178 mm · 7 in.



.1210
Limonadenlöffel
Iced tea spoon
192 mm · 7⁷/₁₆ in.



.1330
Buttermesser²⁾
Butter knife
170 mm · 6¹¹/₁₆ in.



.1890
Buttermesser²⁾
Butter knife
170 mm · 6¹¹/₁₆ in.



.1580
Franz. Saucenlöffel
French sauce spoon
182 mm · 7³/₁₆ in.



.1630
Runder Suppenlöffel
Round soup spoon
178 mm · 7 in.



.1950
Steakmesser
Steak knife
234 mm · 9³/₁₆ in.



.1970
Steakmesser
Steak knife
240 mm · 9⁷/₁₆ in.

Besteck-Einzelteile
Serving pieces

18/10
18/10
versilbert
silver plated

01.0049 03.0149

¹⁾ Hohlheft (18/10)
hollow handle (18/10)

²⁾ ohne Wellenschliff
without serrated blade

ROYAL



KREUZBAND, das traditionsreiche Besteckmodell hat sich seine Ausdruckskraft bis heute erhalten. Dezente Ornamentik, vereint mit stilvollem Dekor und einer hochwertigen Verarbeitung. Ein Besteck, das jede festliche Tafel schmückt.

KREUZBAND, the traditional looking cutlery model from HEPP has retained its power of expression to the present day. Discreet ornamentation combined with stylish décor and high quality workmanship – cutlery to adorn any festive table.



.1010
Esslöffel
Table spoon
209 mm · 8¼ in.



.1020
Essgabel
Table fork
209 mm · 8¼ in.



.1600
Tafelmesser¹⁾
Table knife
248 mm · 9¾ in.



.1800
Tafelmesser
Table knife
248 mm · 9¾ in.



.1050
Dessertlöffel
Dessert spoon
178 mm · 7 in.



.1060
Dessertgabel
Dessert fork
180 mm · 7⅛ in.



.1610
Dessertmesser¹⁾
Dessert knife
213 mm · 8⅝ in.



.1810
Dessertmesser
Dessert knife
213 mm · 8⅝ in.



.1090
Kaffeelöffel
Coffee spoon
142 mm · 5⅝ in.



.1110
Moccalöffel
Demi-Tasse spoon
109 mm · 4⅝ in.



.1120
Kuchengabel
Cake fork
159 mm · 6¼ in.



.1750
Nachspeisegabel
Dessert fork
140 mm · 5½ in.



.1140
Fischmesser
Fish knife
203 mm · 8 in.



.1150
Fischgabel
Fish fork
180 mm · 7⅛ in.



.1160
Obstmesser
Fruit knife
165 mm · 6½ in.



.1180
Consommelöffel
Bouillon spoon
150 mm · 5⅝ in.



.1210
Limonadenlöffel
Iced tea spoon
190 mm · 7½ in.



.1220
Austerngabel
Oyster fork
130 mm · 5⅝ in.



.1330
Buttermesser²⁾
Butter knife
170 mm · 6⅞ in.



.1370
Saucenlöffel
Sauce spoon
183 mm · 7⅜ in.



.1400
Suppens schöpfer
Soup ladle large,
273 mm · 10¾ in.



.1410
Portionsschöpfer
Soup ladle small,
197 mm · 7¾ in.



.1420
Tortenheber
Cake server
231 mm · 9⅝ in.



.1520
Vorlegelöffel
Serving spoon
275 mm · 10⅜ in.



.1530
Vorlegegabel
Serving fork
290 mm · 11⅜ in.



.1550
Steakmesser¹⁾
Steak knife
234 mm · 9⅜ in.



.1580
Franz. Saucenlöffel
French sauce spoon
181 mm · 7⅛ in.



.1630
Runder Suppenlöffel
Round soup spoon
180 mm · 7⅛ in.

Besteck-Einzelteile
Serving pieces

18/10
18/10

versilbert
silver plated

01.0013 03.0113

¹⁾ Hohlheft (18/10)
hollow handle (18/10)

²⁾ ohne Wellenschliff
without serrated blade

KREUZBAND



Das Modell ACCENT von HEPP besticht durch seine gerundeten Formen und harmonischen Proportionen. Vom Charakter her modern macht das designorientierte Besteck einen klassischen Gesamteindruck.

ACCENT from HEPP is impressive with its rounded contours and harmonious proportions. Modern in character, the design oriented cutlery has an overall classic appearance.



.1010 Esslöffel Table spoon 203 mm · 8 in.	.1020 Essgabel Table fork 202 mm · 7 ⁵ / ₁₆ in.	.1800 Tafelmesser Table knife 230 mm · 9 ¹ / ₁₆ in.	.1050 Dessertlöffel Dessert spoon 180 mm · 7 ¹ / ₁₆ in.	.1060 Dessertgabel Dessert fork 179 mm · 7 ¹ / ₁₆ in.	.1810 Dessertmesser Dessert knife 220 mm · 8 ¹¹ / ₁₆ in.	.1100 Kaffeelöffel Coffee spoon 132 mm · 5 ³ / ₁₆ in.	.1110 Moccalöffel Demi-tasse spoon 110 mm · 4 ⁵ / ₁₆ in.
---	--	--	--	--	---	--	---



.1750 Nachspeisegabel Dessert fork 151 mm · 5 ¹⁵ / ₁₆ in.	.1140 Fischmesser Fish knife 204 mm · 8 ¹ / ₁₆ in.	.1150 Fischgabel Fish fork 179 mm · 7 ¹ / ₁₆ in.	.1210 Limonadenlöffel Iced tea spoon 185 mm · 7 ⁵ / ₁₆ in.	.1330 Buttermesser²⁾ Butter knife 170 mm · 6 ¹¹ / ₁₆ in.	.1580 Franz. Saucenlöffel French sauce spoon 183 mm · 7 ³ / ₁₆ in.	.1630 Runder Suppenlöffel Round soup spoon 176 mm · 6 ¹⁵ / ₁₆ in.	.1950 Steakmesser Steak knife 230 mm · 9 ¹ / ₁₆ in.
--	---	---	---	--	---	--	--

Besteck-Einzelteile
Serving pieces

18/10
18/10
versilbert
silver plated

01.0053 03.0153

¹⁾ Hohlheft (18/10)
hollow handle (18/10)

²⁾ ohne Wellenschliff
without serrated blade

ACCENT



Die klaren, trapezförmigen Stilelemente und die Materialstärke der Besteckserie FUTURA geben dem Modell eine wertvolle Optik. Geometrische Elemente unterstreichen die monumental anmutende, zeitlose Schönheit.

The clear, trapeze-shaped style elements and the thickness of the material of the FUTURA range lend the model a lavish appearance. Geometric elements emphasise the extremely solid appearance and timeless beauty.



.1010 Esslöffel Table spoon 200 mm · 7 ⁷ / ₈ in.	.1020 Essgabel Table fork 200 mm · 7 ⁷ / ₈ in.	.1030 Tafelmesser¹⁾ Table knife 225 mm · 8 ⁷ / ₈ in.	.1800 Tafelmesser Table knife 225 mm · 8 ⁷ / ₈ in.	.1050 Dessertlöffel Dessert spoon 185 mm · 7 ⁵ / ₁₆ in.	.1060 Dessertgabel Dessert fork 182 mm · 7 ³ / ₁₆ in.	.1070 Dessertmesser¹⁾ Dessert knife 207 mm · 8 ¹ / ₈ in.	.1810 Dessertmesser Dessert knife 207 mm · 8 ¹ / ₈ in.
---	---	--	---	--	--	--	---



.1100 Kaffeelöffel Coffee spoon 135 mm · 5 ⁵ / ₁₆ in.	.1110 Moccalöffel Demi-tasse spoon 110 mm · 4 ⁹ / ₁₆ in.	.1130 Kuchengabel Cake fork 151 mm · 5 ⁵ / ₁₆ in.	.1140 Fischmesser Fish knife 215 mm · 8 ⁷ / ₁₆ in.	.1150 Fischgabel Fish fork 186 mm · 7 ⁵ / ₁₆ in.	.1210 Limonadenlöffel Iced tea spoon 183 mm · 7 ³ / ₁₆ in.	.1320 Buttermesser^{1) 2)} Butter knife 170 mm · 6 ¹¹ / ₁₆ in.	.1330 Buttermesser²⁾ Butter knife 170 mm · 6 ¹¹ / ₁₆ in.
--	---	--	---	---	---	---	--



.1550 Steakmesser¹⁾ Steak knife 233 mm · 9 ³ / ₁₆ in.	.1580 Franz. Saucenlöffel French sauce spoon 184 mm · 7 ¹ / ₄ in.	.1630 Runder Suppenlöffel Round soup spoon 180 mm · 7 ¹ / ₁₆ in.
---	--	---

Besteck-Einzelteile
Serving pieces

18/10 versilbert
18/10 silver plated

01.0026 03.0126

¹⁾ Hohlheft (18/10)
hollow handle (18/10)

²⁾ ohne Wellenschliff
without serrated blade

FUTURA



Das zarte Blattmotiv des HEPP-Besteckmodells DIAMOND ist meisterhaft verarbeitet und wiederholt sich auf der Rückseite. Die Exklusivität ist zeitlos und bleibt auch nach Jahren bestehen.

The delicate leaf motif of the cutlery model DIAMOND is executed in masterly fashion and repeated on the reverse side. The exclusiveness is ageless and endures for years.



.1010
Esslöffel
Table spoon
205 mm · 8¹/₁₆ in.



.1020
Essgabel
Table fork
205 mm · 8¹/₁₆ in.



.1030
Tafelmesser¹⁾
Table knife
228 mm · 9 in.



.1800
Tafelmesser
Table knife
228 mm · 9 in.



.1830
Tafelmesser
Table knife
228 mm · 9 in.



.1050
Dessertlöffel
Dessert spoon
180 mm · 7¹/₁₆ in.



.1060
Dessertgabel
Dessert fork
180 mm · 7¹/₁₆ in.



.1070
Dessertmesser¹⁾
Dessert knife
206 mm · 8¹/₈ in.



.1810
Dessertmesser
Dessert knife
206 mm · 8¹/₈ in.



.1850
Dessertmesser
Dessert knife
206 mm · 8¹/₈ in.



.1100
Kaffeelöffel
Coffee spoon
140 mm · 5¹/₂ in.



.1110
Moccalöffel
Demi-tasse spoon
120 mm · 4³/₄ in.



.1120
Kuchengabel
Cake fork
155 mm · 6¹/₈ in.



.1140
Fischmesser
Fish knife
208 mm · 8³/₁₆ in.



.1150
Fischgabel
Fish fork
191 mm · 7¹/₂ in.



.1210
Limonadenlöffel
Iced tea spoon
185 mm · 7⁵/₁₆ in.



.1320
Buttermesser¹⁾²⁾
Butter knife
170 mm · 6¹/₁₆ in.



.1330
Buttermesser²⁾
Butter knife
170 mm · 6¹/₁₆ in.



.1470
Vorlegelöffel
Serving spoon
205 mm · 8¹/₁₆ in.



.1480
Vorlegegabel
Serving fork
205 mm · 8¹/₁₆ in.



.1550
Steakmesser¹⁾
Steak knife
234 mm · 9¹/₁₆ in.



.1950
Steakmesser
Steak knife
236 mm · 9¹⁵/₁₆ in.



.1580
Franz. Saucenlöffel
French sauce spoon
185 mm · 7⁵/₁₆ in.



.1630
Runder Suppenlöffel
Round soup spoon
175 mm · 6⁷/₈ in.

Besteck-Einzelteile
Serving pieces

18/10 versilbert
18/10 silver plated

01.0042 03.0142

¹⁾ Hohlheft (18/10)
hollow handle (18/10)

²⁾ ohne Wellenschliff
without serrated blade

DIAMOND



Zeitlose Formen mit umrahmender Facette stehen bei der Besteck-Kollektion EXCLUSIV für Modernität und Klassik. Die Ausgewogenheit der Proportionen schafft eine harmonische, ästhetische Balance.

Timeless shape and faceted border represent modernity and classical style in the EXCLUSIV cutlery collection. The balanced proportions create a harmonious, aesthetic symmetry.



.1650
Esslöffel
Table spoon
203 mm · 8 in.



.1660
Essgabel
Table fork
203 mm · 8 in.



.1670
Tafelmesser¹⁾
Table knife
238 mm · 9⁵/₈ in.



.1800
Tafelmesser
Table knife
238 mm · 9⁵/₈ in.



.1870
Tafelmesser
Table knife
238 mm · 9⁵/₈ in.



.1050
Dessertlöffel
Dessert spoon
180 mm · 7¹/₁₆ in.



.1060
Dessertgabel
Dessert fork
180 mm · 7¹/₁₆ in.



.1070
Dessertmesser¹⁾
Dessert knife
209 mm · 8¹/₄ in.



.1810
Dessertmesser
Dessert knife
209 mm · 8¹/₄ in.



.1850
Dessertmesser
Dessert knife
209 mm · 8¹/₄ in.



.1100
Kaffeelöffel
Coffee spoon
133 mm · 5¹/₄ in.



.1110
Moccalöffel
Demi-tasse spoon
115 mm · 4¹/₂ in.



.1750
Nachspeisegabel
Dessert fork
150 mm · 5⁷/₈ in.



.1140
Fischmesser
Fish knife
203 mm · 8 in.



.1150
Fischgabel
Fish fork
173 mm · 6¹³/₁₆ in.



.1210
Limonadenlöffel
Iced tea spoon
183 mm · 7³/₁₆ in.



.1220
Austergabel
Oyster fork
133 mm · 5¹/₄ in.



.1330
Buttermesser²⁾
Butter knife
163 mm · 6⁵/₁₆ in.



.1550
Steakmesser¹⁾
Steak knife
238 mm · 9⁵/₈ in.



.1580
Franz. Saucenlöffel
French sauce spoon
186 mm · 7⁵/₁₆ in.



.1630
Runder Suppenlöffel
Round soup spoon
176 mm · 6¹⁵/₁₆ in.



.1880
Obstmesser
Fruit knife
157 mm · 6³/₁₆ in.

Besteck-Einzelteile
Serving pieces

18/10
18/10
versilbert
silver plated

01.0025 03.0125

¹⁾ Hohlheft (18/10)
hollow handle (18/10)

²⁾ ohne Wellenschliff
without serrated blade

EXCLUSIV



Makellose Oberflächen und filigrane Relieflinien strahlen zeitlose Eleganz aus ohne aufdringlich zu wirken. Die dezente Ornamentik der Besteckserie FACETTE hält sich elegant im Hintergrund.

Flawless surfaces and filigree bevelling radiate timeless elegance without appearing obtrusive. The restrained ornamentation of the FACETTE cutlery stays elegantly subdued.



.1700
Menüöffel
Table spoon
192 mm · 7⁵/₁₆ in.



.1710
Menügabel
Table fork
192 mm · 7⁵/₁₆ in.



.1720
Menümesser¹⁾
Table knife
217 mm · 8⁵/₁₆ in.



.1840
Menümesser
Table knife
217 mm · 8⁵/₁₆ in.



.1050
Dessertlöffel
Dessert spoon
176 mm · 6¹⁵/₁₆ in.



.1060
Dessertgabel
Dessert fork
176 mm · 6¹⁵/₁₆ in.



.1070
Dessertmesser¹⁾
Dessert knife
200 mm · 7⁷/₈ in.



.1850
Dessertmesser
Dessert knife
200 mm · 7⁷/₈ in.



.1100
Kaffeelöffel
Coffee spoon
135 mm · 5⁵/₁₆ in.



.1110
Moccalöffel
Demi-tasse spoon
118 mm · 4⁹/₁₆ in.



.1150
Fischgabel
Fish fork
188 mm · 7³/₈ in.



.1730
Fischmesser
Fish knife
204 mm · 8¹/₁₆ in.



.1210
Limonadenlöffel
Iced tea spoon
181 mm · 7¹/₈ in.



.1330
Buttermesser²⁾
Butter knife
170 mm · 6¹¹/₁₆ in.



.1630
Runder Suppenlöffel
Round soup spoon
172 mm · 6³/₄ in.



.1740
Nachspeiselöffel
Dessert spoon
154 mm · 6¹/₈ in.



.1750
Nachspeisegabel
Dessert fork
153 mm · 6¹/₁₆ in.



.1860
Buttermesser
Butter knife
165 mm · 6¹/₂ in.



.1950
Steakmesser
Steak knife
213 mm · 8³/₈ in.

Besteck-Einzelteile
Serving pieces

rostfreier Stahl
stainless steel

rostfreier Stahl versilbert
stainless steel silver plated

06.0030

08.0130

¹⁾ Hohlheft (18/10)
hollow handle (18/10)

²⁾ ohne Wellenschliff
without serrated blade

FACETTE



Die Tischkultur des Klassizismus findet in dem HEPP-Besteck TRADITION seine schönste Verkörperung. Das umlaufende Fadendekor ist das prägnanteste Stilelement und steht für Eleganz.

The tableware of classicism finds its most attractive expression in the HEPP cutlery TRADITION. The decorative thread around the edge is the most striking style feature and portrays elegance.



.1010
Esslöffel
Table spoon
205 mm · 8¹/₁₆ in.



.1020
Essgabel
Table fork
205 mm · 8¹/₁₆ in.



.1050
Dessertlöffel
Dessert spoon
180 mm · 7¹/₁₆ in.



.1060
Dessertgabel
Dessert fork
180 mm · 7¹/₁₆ in.



.1070
Dessertmesser¹⁾
Dessert knife
206 mm · 8¹/₈ in.



.1070
Dessertmesser^{1) 3)}
Dessert knife
206 mm · 8¹/₈ in.



.1090
Kaffeelöffel
Coffee spoon
140 mm · 5¹/₂ in.



.1110
Moccalöffel
Demi-tasse spoon
120 mm · 4³/₄ in.



.1120
Kuchengabel
Cake fork
155 mm · 6¹/₈ in.



.1140
Fischmesser
Fish knife
208 mm · 8³/₁₆ in.



.1150
Fischgabel
Fish fork
191 mm · 7¹/₂ in.



.1210
Limonadenlöffel
Iced tea spoon
185 mm · 7⁵/₁₆ in.



.1330
Buttermesser^{2) 3)}
Butter knife
170 mm · 6¹/₁₆ in.



.1550
Steakmesser^{1) 3)}
Steak knife
225 mm · 8⁷/₈ in.



.1580
Franz. Saucenlöffel
French sauce spoon
185 mm · 7⁵/₁₆ in.



.1630
Runder Suppenlöffel
Round soup spoon
175 mm · 6⁷/₈ in.



.1670
Tafelmesser¹⁾
Table knife
228 mm · 9 in.



.1670
Tafelmesser^{1) 3)}
Table knife
228 mm · 9 in.



.1740
Nachspeiselöffel
Dessert spoon
155 mm · 6¹/₈ in.



.1800
Tafelmesser³⁾
Table knife
228 mm · 9 in.



.1810
Dessertmesser³⁾
Dessert knife
206 mm · 8¹/₈ in.



.1850
Dessertmesser
Dessert knife
206 mm · 8¹/₈ in.



.1850
Dessertmesser³⁾
Dessert knife
206 mm · 8¹/₈ in.



.1870
Tafelmesser
Table knife
228 mm · 9 in.



.1870
Tafelmesser³⁾
Table knife
228 mm · 9 in.

Besteck-Einzelteile
Servicing pieces

18/10
18/10

versilbert
silver plated

18/10
18/10

versilbert
silver plated

01.0022

03.0122

01.0024³⁾

03.0124³⁾

¹⁾ Hohlheft (18/10)
hollow handle (18/10)

²⁾ ohne Wellenschliff
without serrated blade

³⁾ Designvariante
alternative design

TRADITION



Stilistische Elemente der Antike spiegeln sich in den Details der Besteckserie ALPHA wider. Die gerillt ausgeführten Griffstücke erfüllen den Wunsch nach repräsentativer Einzigartigkeit.

Stylish elements of antiquity are reflected in the details of the ALPHA cutlery range. The ridges along the handle fulfil the desire for prestigious individuality.



.1010
Esslöffel
Table spoon
202 mm · 7¹⁵/₁₆ in.



.1020
Essgabel
Table fork
203 mm · 8 in.



.1800
Tafelmesser
Table knife
237 mm · 9⁵/₁₆ in.



.1050
Dessertlöffel
Dessert spoon
180 mm · 7¹/₁₆ in.



.1060
Dessertgabel
Dessert fork
179 mm · 7¹/₁₆ in.



.1810
Dessertmesser
Dessert knife
200 mm · 7⁷/₈ in.



.1100
Kaffeelöffel
Coffee spoon
133 mm · 5¹/₄ in.



.1110
Moccalöffel
Demi-tasse spoon
115 mm · 4¹/₂ in.



.1140
Fischmesser
Fish knife
221 mm · 8¹¹/₁₆ in.



.1150
Fischgabel
Fish fork
182 mm · 7³/₁₆ in.



.1210
Limonadenlöffel
Iced tea spoon
194 mm · 7⁷/₈ in.



.1330
Buttermesser²⁾
Butter knife
169 mm · 6⁵/₈ in.



.1580
Franz. Saucenlöffel
French sauce spoon
186 mm · 7⁵/₁₆ in.



.1630
Runder Suppenlöffel
Round soup spoon
178 mm · 7 in.



.1750
Nachspeisegabel
Dessert fork
155 mm · 6¹/₈ in.



.1950
Steakmesser
Steak knife
236 mm · 9⁵/₁₆ in.

Besteck-Einzelteile
Serving pieces

18/10
18/10
versilbert
silver plated

01.0052 03.0152

¹⁾ Hohlheft (18/10)
hollow handle (18/10)

²⁾ ohne Wellenschliff
without serrated blade

ALPHA



Keinesfalls aristokratisch, aber im Stil der traditionellen Tafel ist PRINCESS ein Beweis dafür, dass verspielte Designelemente auch heute im Trend der Zeit absolut angesagt sind.

In no way aristocratic but in the style of the traditional dining table, PRINCESS is the proof that playful design elements are undoubtedly called for in the current trend.



.1700 Menüöffel Table spoon 192 mm · 7 ⁵ / ₁₆ in.	.1710 Menügabel Table fork 193 mm · 7 ⁵ / ₈ in.	.1720 Menümesser¹⁾ Table knife 218 mm · 8 ⁹ / ₁₆ in.	.1840 Menümesser Table knife 218 mm · 8 ⁹ / ₁₆ in.	.1050 Dessertlöffel Dessert spoon 176 mm · 6 ¹⁵ / ₁₆ in.	.1060 Dessertgabel Dessert fork 177 mm · 6 ¹⁵ / ₁₆ in.	.1070 Dessertmesser¹⁾ Dessert knife 200 mm · 7 ⁷ / ₈ in.	.1850 Dessertmesser Dessert knife 200 mm · 7 ⁷ / ₈ in.
--	--	--	---	---	---	--	---



.1100 Kaffeelöffel Coffee spoon 135 mm · 5 ⁵ / ₁₆ in.	.1110 Moccalöffel Demi-tasse spoon 118 mm · 4 ⁹ / ₈ in.	.1730 Fischmesser Fish knife 204 mm · 8 ¹ / ₁₆ in.	.1150 Fischgabel Fish fork 180 mm · 7 ¹ / ₁₆ in.	.1180 Consommelöffel Bouillon spoon 163 mm · 6 ⁷ / ₁₆ in.	.1210 Limonadenlöffel Iced tea spoon 181 mm · 7 ¹ / ₈ in.	.1220 Austergabel Oyster fork 134 mm · 5 ¹ / ₄ in.	.1330 Buttermesser²⁾ Butter knife 170 mm · 6 ¹¹ / ₁₆ in.
--	--	---	---	--	--	---	--

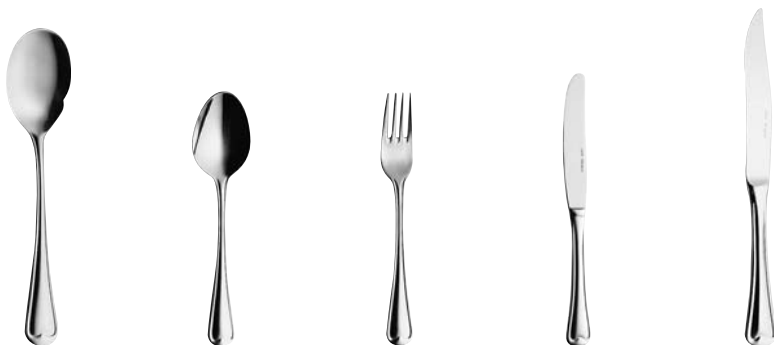

.1580 Franz. Saucenlöffel French sauce spoon 183 mm · 7 ³ / ₁₆ in.	.1740 Nachspeiselöffel Dessert spoon 155 mm · 6 ¹ / ₈ in.	.1750 Nachspeisegabel Dessert fork 153 mm · 6 ¹ / ₁₆ in.	.1860 Obstmesser fruit knife 164 mm · 6 ⁷ / ₁₆ in.	.1950 Steakmesser Steak knife 202 mm · 7 ¹⁵ / ₁₆ in.
---	--	---	---	---

Besteck-Einzelteile
Serving pieces

rostfreier Stahl
stainless steel

rostfreier Stahl versilbert
stainless steel silver plated

06.0020

08.0120

¹⁾ Hohlheft (18/10)
hollow handle (18/10)

²⁾ ohne Wellenschliff
without serrated blade

PRINCESS



Die vom Diamantschliff inspirierte Form und die gekanteten Griffenden deuten bei CARAT auf höchste Verarbeitungsqualität, anspruchsvolles Design und vollendete Oberflächenbeschaffenheit hin.

The perfect shape, inspired by the cut of diamonds, with bevelled edges around the handles is an indication of the highest quality of workmanship, sophisticated design and ideal surface texture of the CARAT cutlery range.



.1010
Esslöffel
Table spoon
195 mm · 7¹¹/₁₆ in.



.1020
Essgabel
Table fork
197 mm · 7⁷/₄ in.



.1030
Tafelmesser¹⁾
Table knife
223 mm · 8³/₄ in.



.1830
Tafelmesser
Table knife
223 mm · 8³/₄ in.



.1050
Dessertlöffel
Dessert spoon
183 mm · 7³/₁₆ in.



.1060
Dessertgabel
Dessert fork
182 mm · 7³/₁₆ in.



.1070
Dessertmesser¹⁾
Dessert knife
209 mm · 8¹/₄ in.



.1850
Dessertmesser
Dessert knife
209 mm · 8¹/₄ in.



.1100
Kaffeelöffel
Coffee spoon
135 mm · 5⁵/₁₆ in.



.1110
Moccalöffel
Demi-tasse spoon
107 mm · 4²/₁₆ in.



.1130
Kuchengabel
Cake fork
151 mm · 5⁵/₁₆ in.



.1140
Fischmesser
Fish knife
215 mm · 8⁷/₁₆ in.



.1150
Fischgabel
Fish fork
178 mm · 7 in.



.1210
Limonadenlöffel
Iced tea spoon
184 mm · 7¹/₄ in.



.1220
Austergabel
Oyster fork
134 mm · 5¹/₄ in.



.1330
Buttermesser²⁾
Butter knife
170 mm · 6¹¹/₁₆ in.



.1550
Steakmesser¹⁾
Steak knife
230 mm · 9¹/₁₆ in.



.1630
Runder Suppenlöffel
Round soup spoon
172 mm · 6³/₄ in.



.1740
Nachspeiselöffel
Dessert spoon
152 mm · 6 in.

Besteck-Einzelteile
Serving pieces

18/10
18/10
versilbert
silver plated

01.0035 03.0135

¹⁾ Hohlheft (18/10)
hollow handle (18/10)

²⁾ ohne Wellenschliff
without serrated blade

CARAT



Bezeichnend für die „Grande Dame“ unter den HEPP Bestecken ist VICTORIA mit dem umrandeten Lorbeer-Fries. Ein außergewöhnliches und extravagantes Besteck, das einen hohen Erinnerungswert trägt.

Characteristic for the „Grand Dame“ of all HEPP cutlery models is the laurel frieze edging. Unusual and extravagant cutlery that is immediately recognisable.

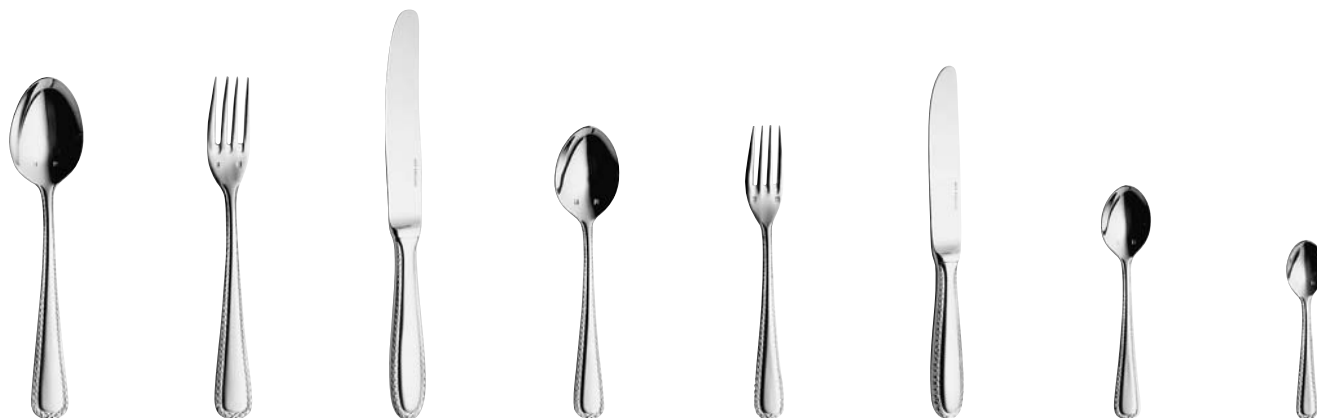

.1010
Esslöffel
Table spoon
209 mm · 8¼ in.

.1020
Essgabel
Table fork
209 mm · 8¼ in.

.1800
Tafelmesser
Table knife
248 mm · 9¾ in.

.1050
Dessertlöffel
Dessert spoon
178 mm · 7 in.

.1060
Dessertgabel
Dessert fork
180 mm · 7¼ in.

.1810
Dessertmesser
Dessert knife
213 mm · 8⅜ in.

.1090
Kaffeelöffel
Coffee spoon
142 mm · 5⅝ in.

.1110
Moccalöffel
Demi-tasse spoon
109 mm · 4⅝ in.



.1120
Kuchengabel
Cake fork
159 mm · 6¼ in.

.1140
Fischmesser
Fish knife
203 mm · 8 in.

.1150
Fischgabel
Fish fork
180 mm · 7⅞ in.

.1210
Limonadenlöffel
Iced tea spoon
190 mm · 7½ in.

.1330
Buttermesser²⁾
Butter knife
170 mm · 6⅞ in.

.1580
Franz. Saucenlöffel
French sauce spoon
181 mm · 7⅞ in.

.1630
Runder Suppenlöffel
Round soup spoon
180 mm · 7⅞ in.

.1950
Steakmesser
Steak knife
230 mm · 9⅞ in.

Besteck-Einzelteile
Serving pieces

18/10
18/10
versilbert
silver plated

01.0046 03.0146

¹⁾ Hohlheft (18/10)
hollow handle (18/10)

²⁾ ohne Wellenschliff
without serrated blade

VICTORIA



Durch seine pflegeleichte Oberfläche und die klare Linie eignet sich das moderne Tafelbesteck TREND für den täglichen Einsatz und sorgt stets für den perfekt gedeckten Tisch.

With its easy care finish and clear lines, the modern TREND cutlery is ideal for daily use and the table setting always look perfect.

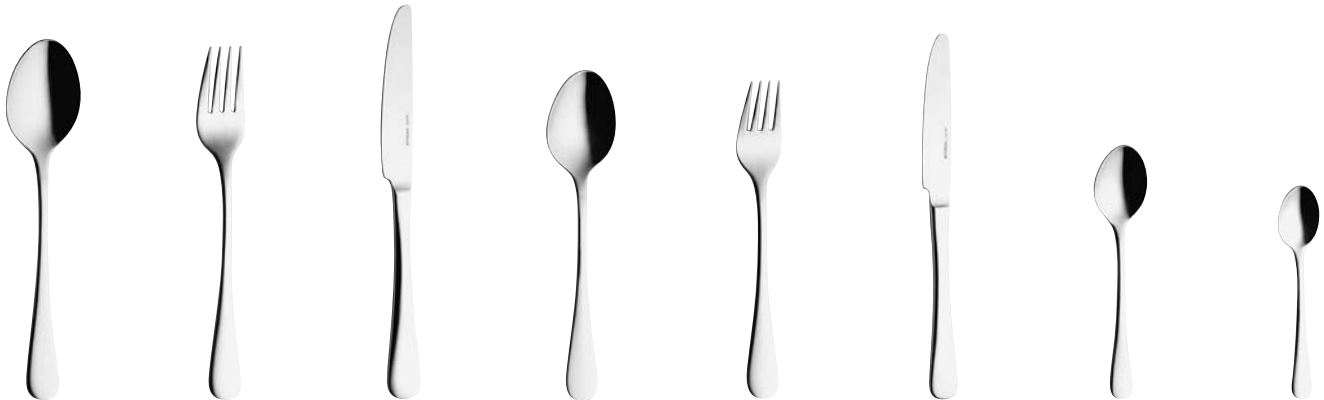

.1700
Menüöffel
Table spoon
197 mm · 7¾ in.

.1710
Menügabel
Table fork
193 mm · 7⅝ in.

.1840
Menümesser
Table knife
217 mm · 8⅞ in.

.1050
Dessertlöffel
Dessert spoon
180 mm · 7⅛ in.

.1060
Dessertgabel
Dessert fork
175 mm · 6⅞ in.

.1850
Dessertmesser
Dessert knife
201 mm · 7⅝⅙ in.

.1100
Kaffeelöffel
Coffee spoon
139 mm · 5⅛ in.

.1110
Moccalöffel
Demi-tasse spoon
118 mm · 4⅝ in.



.1150
Fischgabel
Fish fork
180 mm · 7⅛ in.

.1210
Limonadenlöffel
Iced tea spoon
190 mm · 7½ in.

.1630
Runder Suppenlöffel
Round soup spoon
178 mm · 7 in.

.1730
Fischmesser
Fish knife
203 mm · 8 in.

.1750
Nachspeisegabel
Dessert fork
142 mm · 5⅝⅙ in.

Besteck-Einzelteile
Serving pieces

18/10
18/10
versilbert
silver plated

06.0047 08.0147

¹⁾ Hohlheft (18/10)
hollow handle (18/10)

²⁾ ohne Wellenschliff
without serrated blade

TREND



Schnörkelloses, klares und funktionales Design für den Gastgeber, der urbane Restaurantkultur vermittelt, stehen für das Besteckmodell PREMIUM. Die hochglanzpolierten Oberflächen sind besonders pflegeleicht.

The PREMIUM cutlery model stands for unembellished, clear and functional design for the caterer conveying urbane restaurant culture. With easy care mirror finish surfaces.



.1700
Menüöffel
Table spoon
193 mm · 7⁵/₈ in.



.1710
Menügabel
Table fork
194 mm · 7⁵/₈ in.



.1840
Menümesser
Table knife
207 mm · 8¹/₈ in.



.1050
Dessertlöffel
Dessert spoon
179 mm · 7¹/₁₆ in.



.1060
Dessertgabel
Dessert fork
180 mm · 7¹/₁₆ in.



.1850
Dessertmesser
Dessert knife
196 mm · 7¹¹/₁₆ in.



.1100
Kaffeelöffel
Coffee spoon
135 mm · 5⁵/₁₆ in.



.1110
Moccalöffel
Demi-tasse spoon
110 mm · 4⁵/₁₆ in.



.1210
Limonadenlöffel
Iced tea spoon
209 mm · 8¹/₄ in.



.1220
Austerngabel
Oyster fork
130 mm · 5¹/₈ in.



.1580
Franz. Saucenlöffel
French sauce spoon
183 mm · 7³/₁₆ in.



.1630
Runder Suppenlöffel
Round soup spoon
179 mm · 7¹/₁₆ in.



.1730
Fischmesser
Fish knife
203 mm · 8 in.



.1740
Nachspeiselöffel
Dessert spoon
155 mm · 6¹/₈ in.



.1750
Nachspeisegabel
Dessert fork
140 mm · 5¹/₂ in.



.1860
Buttermesser
Butter knife
170 mm · 6¹¹/₁₆ in.



.1950
Steakmesser
Steak knife
220 mm · 8¹¹/₁₆ in.



.1960
Steakmesser¹⁾
Steak knife
216 mm · 8¹/₂ in.

Besteck-Einzelteile
Serving pieces

rostfreier Stahl
stainless steel

rostfreier Stahl versilbert
stainless steel silver plated

18/10
18/10

versilbert
silver plated

06.0010

08.0110

06.0011

08.0111

¹⁾ Hohlheft (18/10)
hollow handle (18/10)

²⁾ ohne Wellenschliff
without serrated blade

PREMIUM



Funktional und reduziert präsentiert sich die Besteckserie INTERLINE. Puristisch, klar in der Kontur wurde es für die verschiedensten Gastronomiewelten entwickelt.

INTERLINE is functional and moderate in appearance. Purist and with well defined contours, it was designed for the most diverse catering environments.



.1010 Esslöffel Table spoon 205 mm · 8 ¹ / ₁₆ in.	.1020 Essgabel Table fork 205 mm · 8 ¹ / ₁₆ in.	.1030 Tafelmesser¹⁾ Table knife 218 mm · 8 ⁹ / ₁₆ in.	.1830 Tafelmesser Table knife 218 mm · 8 ⁹ / ₁₆ in.	.1800 Tafelmesser³⁾ Table knife 229 mm · 9 in.	.1050 Dessertlöffel Dessert spoon 173 mm · 6 ¹³ / ₁₆ in.	.1060 Dessertgabel Dessert fork 175 mm · 6 ⁷ / ₈ in.	.1080 Dessertmesser¹⁾ Dessert knife 184 mm · 7 ¹ / ₄ in.
--	--	---	--	--	---	---	--

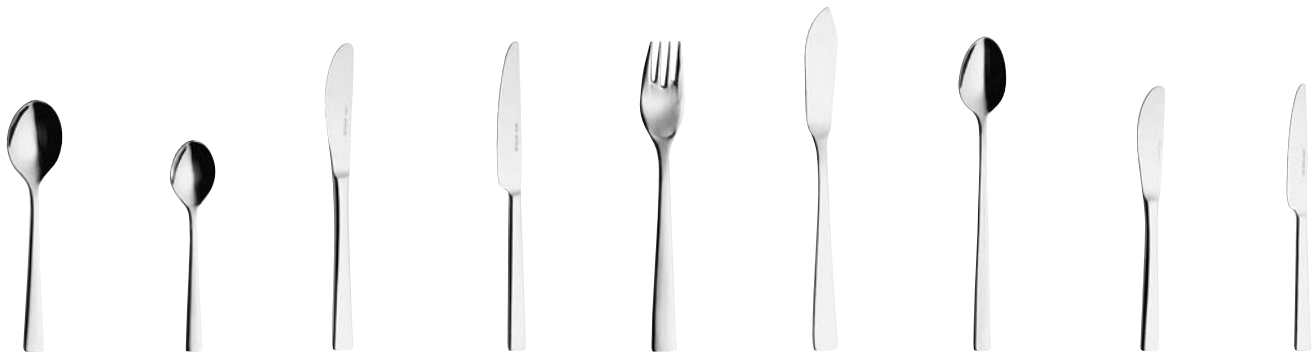

.1100 Kaffeelöffel Coffee spoon 134 mm · 5 ¹ / ₄ in.	.1780 Moccalöffel Demi-Tasse spoon 121 mm · 4 ³ / ₄ in.	.1850 Dessertmesser Dessert knife 184 mm · 7 ¹ / ₄ in.	.1850 Dessertmesser³⁾ Dessert knife 184 mm · 7 ¹ / ₄ in.	.1150 Fischgabel Fish fork 187 mm · 7 ³ / ₈ in.	.1730 Fischmesser Fish knife 206 mm · 8 ¹ / ₈ in.	.1210 Limonadenlöffel Iced tea spoon 190 mm · 7 ¹ / ₂ in.	.1860 Buttermesser Butter knife 163 mm · 6 ³ / ₄ in.	.1860 Buttermesser³⁾ Butter knife 163 mm · 6 ³ / ₄ in.
---	--	---	--	--	--	--	---	--

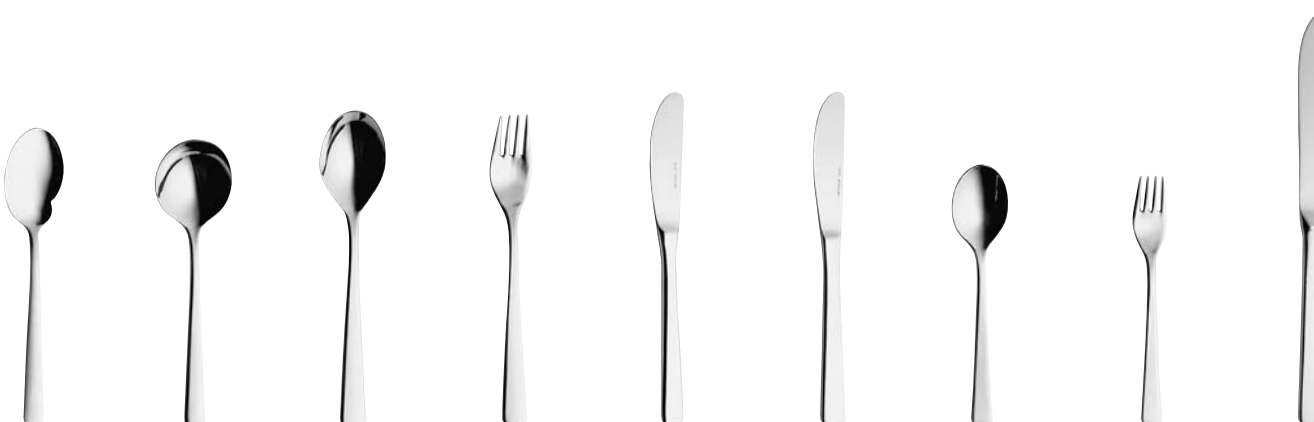

.1580 Franz. Saucenlöffel French sauce spoon 183 mm · 7 ³ / ₁₆ in.	.1630 Runder Suppenlöffel Round soup spoon 180 mm · 7 ¹ / ₁₆ in.	.1700 Menülöffel Table spoon 193 mm · 7 ⁵ / ₈ in.	.1710 Menügabel Table fork 187 mm · 7 ³ / ₈ in.	.1720 Menümesser¹⁾ Table knife 204 mm · 8 ¹ / ₁₆ in.	.1840 Menümesser Table knife 204 mm · 8 ¹ / ₁₆ in.	.1740 Nachspeiselöffel Dessert spoon 154 mm · 6 ¹ / ₁₆ in.	.1750 Nachspeisegabel Dessert fork 152 mm · 6 in.	.1950 Steakmesser Steak knife 237 mm · 9 ⁵ / ₁₆ in.
---	---	--	--	--	---	---	--	--

Besteck-Einzelteile
Serving pieces

18/10
18/10

versilbert
silver plated

rostfreier Stahl
stainless steel

rostfreier Stahl versilbert
stainless steel silver plated

01.0005

03.0105

06.0005³⁾

08.0105³⁾

¹⁾ Hohlheft (18/10)
hollow handle (18/10)

²⁾ ohne Wellenschliff
without serrated blade

³⁾ Designvariante
alternative design

INTERLINE



ERGÄNZUNGSTEILE · CUTLERY ADDITIONAL PIECES



Universalzange, All purpose tongs

Länge length		18/10	
mm	in.	18/10	
230	9 ¹ / ₁₆		60.5446.0000



Salatzange, Salad tongs

Länge length		18/10	
mm	in.	18/10	
295	11 ⁵ / ₈		60.5438.0000



Salatzange, Salad tongs

Länge length		18/10	
mm	in.	18/10	
240	9 ⁷ / ₁₆		60.5475.0000



Spaghettizange, Spaghetti tongs

Länge length		18/10	
mm	in.	18/10	
240	9 ⁷ / ₁₆		60.5476.0000



Vorlegelöffel für Chafing Dish, Serving spoon for Chafing Dish

Länge length		18/10	versilbert silver plated
mm	in.	18/10	
400	15 ³ / ₄	12.5072.4000	13.6072.4000



Vorlegegabel für Chafing Dish, Serving fork for Chafing Dish

Länge length		18/10	versilbert silver plated
mm	in.	18/10	
400	15 ³ / ₄	12.5073.4000	13.6073.4000



Bowlenlöffel, Punch bowl ladle

Länge length		18/10	versilbert silver plated
mm	in.	18/10	
330	13	12.5058.0000	13.6058.0000



Käsemesser, Cheese knife

Länge length		18/10	
mm	in.	18/10	
260	10 ¹ / ₄		60.5469.0000

Steakhaus-Messer, Steakhouse knife

Länge length		18/10	18/10 matt
mm	in.	18/10	18/10 satin finish
253	9 ¹⁵ / ₁₆	12.5075.0010	12.5075.0000



Steakhaus-Gabel, Steakhouse fork

Länge length		18/10	18/10 matt
mm	in.	18/10	18/10 satin finish
212	8 ³ / ₈	12.5077.0010	12.5077.0000



Party-Löffel, Party spoon

Länge length			18/10
mm	in.		18/10
134	5 ¹ / ₄		01.0005.1200



Universal-Löffel-Gabel, Comb. Spoon-Fork

Länge length			18/10
mm	in.		18/10
184	7 ⁴ / ₁₆		01.0048.1270



Schneckenzange, Snail tongs

Länge length		18/10	versilbert
mm	in.	18/10	silver plated
150	5 ⁷ / ₈	12.5050.0000	13.6050.0000



Gebäckzange, Pastry tongs

Länge length		18/10	versilbert
mm	in.	18/10	silver plated
175	6 ⁷ / ₈	12.5051.0000	13.6051.0000



Geflügelschere, Poultry scissors

Länge length			vernickelt
mm	in.		nickelplated
255	10 ¹ / ₁₆		12.5052.0000



Zuckerzange, Sugar tongs

Länge length		18/10	versilbert
mm	in.	18/10	silver plated
90	3 ⁹ / ₁₆	12.5053.0000	13.6053.0000



ERGÄNZUNGSTEILE · CUTLERY ADDITIONAL PIECES



Hummergabel, Lobster fork

Länge length		18/10 18/10	versilbert silver plated
mm	in.		
220	8 ¹¹ / ₁₆	12.5054.0000	13.6054.0000



Hummerzange, Lobster crack

Länge length			18/10 18/10
mm	in.		
197	7 ³ / ₄		60.8942.0000



Traubenschere, Grape scissors

Länge length		18/10 18/10	versilbert silver plated
mm	in.		
150	5 ⁷ / ₈	12.5055.0000	13.6055.0000



Nußknacker, Nut cracker

Länge length			vernickelt nickelplated
mm	in.		
170	6 ¹¹ / ₁₆		12.5057.0000



Tischroller, Crumb scraper

Länge length			versilbert silver plated
mm	in.		
140 x 150	5 ¹ / ₂ x 5 ⁷ / ₈		60.9192.0000



Krümelschaufel, Crumb scraper

Länge length		18/10 18/10	versilbert silver-plated
mm	in.		
230	9 ¹ / ₁₆	12.2154.0000	13.3154.0000



Krümelsammler, Table crumbler

Länge length			18/10 18/10
mm	in.		
150	5 ⁷ / ₈		60.5427.0000

Kaviarmesser, Caviar knife

Länge
length

mm in.

137 5³/₈

Perlmutter
nacre

60.9194.0000



Kaviarschaufel, Caviar spoon

Länge
length

mm in.

127 5

Perlmutter
nacre

60.9195.0000



BESTECKSTÄNDER · CUTLERY HOLDER

Besteckständer, Cutlery holder

Länge length		Breite width		Höhe height		18/10 18/10
mm	in.	mm	in.	mm	in.	
250	9 ¹³ / ₁₆	160	6 ⁵ / ₁₆	300	11 ¹⁹ / ₁₆	12.0605.0000



NEUTRAL



Menüöffel, Table spoon

Länge length		18/10 18/10	rostfreier Stahl stainless steel
mm	in.		
197	7 ³ / ₄	06.0547.1700	06.0055.1700

TREND



Menügabel, Table fork

Länge length		18/10 18/10	rostfreier Stahl stainless steel
mm	in.		
193	7 ⁵ / ₈	06.0547.1710	06.0055.1710

TREND



Menümesser, Table knife

Länge length			rostfreier Stahl stainless steel
mm	in.		
217	8 ⁹ / ₁₆	06.0547.1840	06.0055.1840

TREND



Kaffeeöffel, Coffee spoon

Länge length		18/10 18/10	rostfreier Stahl stainless steel
mm	in.		
139	5 ¹ / ₂	06.0547.1100	06.0055.1100

TREND



Kuchengabel, Cake fork

Länge length		18/10 18/10	rostfreier Stahl stainless steel
mm	in.		
142	5 ⁹ / ₁₆	06.0547.1750	06.0055.1750

TREND



Ein glänzender Start in den Tag

Die Produkte von HEPP aus hochwertigen Materialien für Frühstück, Frühstücksbuffet, Nachmittagstee und Kaffee werden für den anspruchsvollen Gast geschaffen – für den zeitgemäße Tischkultur und die Freude am Außergewöhnlichen zur persönlichen Philosophie gehören. Ob morgens, mittags oder zur „Tea-time“ – einem liebevoll eingedeckten Tisch mit duftenden Köstlichkeiten auf funkelndem Tafel-silber kann sich niemand entziehen.

A brilliant start to your day

HEPP's hollowware made of high-quality materials for breakfast, the breakfast buffet, afternoon tea and coffee are created for discerning guests. For them, contemporary table culture and appreciating the extraordinary are part of their personal philosophy. Whether it's morning, afternoon or teatime – a table lovingly set with fragrant delicacies on sparkling silver tableware is quite irresistible.



FRÜHSTÜCK · BREAKFAST



FRÜHSTÜCK · BREAKFAST

Saftständer, Juice stand
drehbar, ohne Einsätze, revolving, without inserts

Höhe height		Ø-Außen Ø-outer		18/10 18/10	versilbert silver-plated
mm	in.	mm	in.		
775	30½	516	20 ⁵ / ₁₆	12.2261.0000	13.2261.0000



NEUTRAL

Universalständer, Multi purpose stand
drehbar, ohne Einsätze, revolving, without inserts

Höhe height		Ø-Außen Ø-outer		18/10 18/10	versilbert silver-plated
mm	in.	mm	in.		
760	29 ¹⁵ / ₁₆	497	19 ⁹ / ₁₆	12.2358.0000	15.2358.0000



NEUTRAL

Glaskrug, Glass jug

Inhalt cap.		Glas glass	
Ltr.	oz.		
2,00	70	50.8867.2000	



NEUTRAL

**Kühlpellet, Cooling pellet
für Saftständer, for juice stand**

Ø-Außen Ø-outer		Kunststoff plastics	
mm	in.		
190	7½	60.8815.0000	



NEUTRAL

Universalschale, All purpose dish

Inhalt cap.		Höhe height		Ø-Außen Ø-outer		18/10	versilbert silver-plated
Ltr.	oz.	mm	in.	mm	in.	18/10	
1,5	53	84	3 ⁵ / ₁₆	232	9 ¹ / ₈	60.5454.0000	60.7454.0000



NEUTRAL

Glaseinsatz, Glass insert

Inhalt cap.		Höhe height		Ø-Außen Ø-outer		Glas glass
Ltr.	oz.	mm	in.	mm	in.	
2,00	70	105	4 ¹ / ₈	230	9 ¹ / ₁₆	50.8361.2250



NEUTRAL

FRÜHSTÜCK · BREAKFAST

Porzellan-Einsatz, Porcelain insert

Inhalt cap.		Höhe height		Ø-Außen Ø-outer		Porzellan porcelain
Ltr.	oz.	mm	in.	mm	in.	
0,80	28	88	3 ⁷ / ₁₆	145	5 ¹¹ / ₁₆	50.8362.1500



NEUTRAL

Scharnierdeckel, Hinged lid für Glaseinsatz Nr. 50.8361.2250, for glass insert No. 50.8361.2250

Ø-Außen Ø-outer		Kunststoff plastics
mm	in.	
237	9 ⁵ / ₁₆	60.8830.2300



NEUTRAL

Saftspender, Juice dispenser

Inhalt cap.		Breite width		Höhe height		18/10	versilbert silver-plated
Ltr.	oz.	mm	in.	mm	in.	18/10	
4,60	162	250	9 ¹³ / ₁₆	485	19 ¹ / ₈	12.2378.0050	15.2378.0050



EXCLUSIVE

Saftspender, Juice dispenser

Inhalt cap.		Länge length		Breite width		Höhe height		18/10	versilbert silver-plated
Ltr.	oz.	mm	in.	mm	in.	mm	in.	18/10	
4,60	162	350	13 ³ / ₄	241	9 ¹ / ₂	495	19 ¹ / ₂	12.2380.0050	15.2380.0050



EXCELLENT

Flaschenkühler, Bottle-cooler
für 4 Saftflaschen, for 4 juice bottles

Länge length		Breite width		Gewicht weight		18/10 18/10	
mm	in.	mm	in.	g	oz.		
541	21 ⁵ / ₁₆	165	6 ¹ / ₂	5000	161	12.2196.0000	



NEUTRAL

Coffee Urn

Inhalt cap.		Breite width		Höhe height		18/10 18/10		versilbert silver-plated	
Ltr.	oz.	mm	in.	mm	in.				
5,00	176	270	10 ⁵ / ₈	550	21 ⁵ / ₈	12.3477.0050	15.3477.0050		
10,00	352	290	11 ⁷ / ₁₆	600	23 ⁵ / ₈	12.3477.0100	15.3477.0100		
15,00	528	309	12 ³ / ₁₆	670	26 ³ / ₈	12.3477.0150	15.3477.0150		



EXCLUSIVE

Coffee Urn

Inhalt cap.		Breite width		Höhe height		18/10 18/10		versilbert silver-plated	
Ltr.	oz.	mm	in.	mm	in.				
5,00	176	282	11 ¹ / ₈	555	21 ⁷ / ₈	12.7077.0050	15.7577.0050		
10,00	352	286	11 ¹ / ₄	605	23 ¹³ / ₁₆	12.7077.0100	15.7577.0100		
15,00	528	287	11 ⁵ / ₁₆	695	27 ³ / ₈	12.7077.0150	15.7577.0150		



TRADITION

Coffee Urn

Inhalt cap.		Breite width		Höhe height		18/10 18/10		versilbert silver-plated	
Ltr.	oz.	mm	in.	mm	in.				
5,00	176	253	9 ¹⁵ / ₁₆	480	18 ⁷ / ₈	12.2377.0050	15.2377.0050		
10,00	352	290	11 ⁷ / ₁₆	570	22 ⁷ / ₁₆	12.2377.0100	15.2377.0100		
15,00	528	309	12 ³ / ₁₆	650	25 ⁹ / ₁₆	12.2377.0150	15.2377.0150		



EXCELLENT

FRÜHSTÜCK · BREAKFAST



Coffee Urn

Inhalt cap.		Breite width		Höhe height		18/10	versilbert silver-plated
Ltr.	oz.	mm	in.	mm	in.	18/10	
5,00	176	253	9 ¹⁵ / ₁₆	455	17 ¹⁵ / ₁₆	12.4877.0050	15.4877.0050
10,00	352	298	11 ³ / ₄	520	20 ¹ / ₂	12.4877.0100	15.4877.0100
15,00	528	309	12 ³ / ₁₆	600	23 ³ / ₈	12.4877.0150	15.4877.0150

PROFILE



Coffee Urn

Inhalt cap.		Breite width		Höhe height		18/10	versilbert silver-plated
Ltr.	oz.	mm	in.	mm	in.	18/10	
5,00	176	253	9 ¹⁵ / ₁₆	455	17 ¹⁵ / ₁₆	12.5277.0050	15.5277.0050
10,00	352	298	11 ³ / ₄	520	20 ¹ / ₂	12.5277.0100	15.5277.0100
15,00	528	309	12 ³ / ₁₆	600	23 ³ / ₈	12.5277.0150	15.5277.0150

ARTE



Coffee Urn
isoliert, insulated

Inhalt cap.		Breite width		Höhe height		18/10	versilbert silver-plated
Ltr.	oz.	mm	in.	mm	in.	18/10	
5,00	176	271	10 ¹¹ / ₁₆	523	20 ⁹ / ₁₆	12.2383.0050	15.2383.0050
10,00	352	315	12 ³ / ₈	611	24 ¹ / ₁₆	12.2383.0100	15.2383.0100

EXCELLENT



Coffee Urn
isoliert, insulated

Inhalt cap.		Breite width		Höhe height		18/10	versilbert silver-plated
Ltr.	oz.	mm	in.	mm	in.	18/10	
5,00	176	270	10 ⁵ / ₈	520	20 ¹ / ₂	12.2483.0050	15.2483.0050
10,00	352	316	12 ⁷ / ₁₆	583	22 ¹⁵ / ₁₆	12.2483.0100	15.2483.0100

EXCLUSIVE

Elektroheizung, Heating element
für Coffee Urn 5,00 ltr., for coffee urn 176 oz.

Ø-Außen Ø-outer		Heizleistung heating efficiency	Netzspannung line voltage	
mm	in.	Watt	Volt	
172	6 ³ / ₄	150	110-240	
172	6 ³ / ₄	130	110-120	
			60.8881.0110	60.8881.0140



NEUTRAL

Elektroheizung, Heating element
für Coffee Urn 10,00 ltr., 15,00 ltr., for coffee urn 352 oz, 528 oz

Ø-Außen Ø-outer		Heizleistung heating efficiency	Netzspannung line voltage	
mm	in.	Watt	Volt	
213	8 ³ / ₈	150	110-240	
213	8 ³ / ₈	130	110-120	
			60.8881.0010	60.8881.0040



NEUTRAL

Brennerdose, Burner tin
für Brennpaste, for dry fuel burner

Ø-Außen Ø-outer		Höhe height	
mm	in.	mm	in.
94	3 ¹¹ / ₁₆	18	18
		10	10
			60.8884.0000



NEUTRAL

Brennpaste, Dry fuel burner

Inhalt cap.		Höhe height	
Ltr.	oz.	mm	in.
0,20	7	55	2 ³ / ₁₆
			60.8960.0000



NEUTRAL

FRÜHSTÜCK · BREAKFAST



Samowar, Samovar

Inhalt cap.		Breite width		Höhe height		Netzspannung line voltage	versilbert silver-plated
Ltr.	oz.	mm	in.	mm	in.	Volt	
5,00	176	300	11 ¹³ / ₁₆	570	22 ⁷ / ₁₆	220	60.8490.0000

NEUTRAL



Butterdose, Butter dish
2-tlg., 2 part

Höhe height		Ø-Außen Ø-outer		18/10	versilbert silver-plated
mm	in.	mm	in.	18/10	
56	2 ³ / ₁₆	169	6 ¹⁰ / ₁₆	12.8118.1600	13.8118.1600
75	2 ¹⁵ / ₁₆	230	9 ¹ / ₁₆	12.8118.2200	13.8118.2200

NEUTRAL



Eierbecher, Egg cup

Höhe height		Ø-Außen Ø-outer		18/10	versilbert silver-plated
mm	in.	mm	in.	18/10	
20	1 ³ / ₁₆	86	3 ³ / ₈	60.8826.0000	60.9026.0000

NEUTRAL



Brotkorb, Bread basket
oval

Länge length		Breite width		Höhe height		18/10	versilbert silver-plated
mm	in.	mm	in.	mm	in.	18/10	
308	12 ¹ / ₈	165	6 ¹ / ₂	50	1 ¹⁵ / ₁₆	60.5483.3080	60.7483.3080

NEUTRAL

Toastständer, Toast rack

Länge length		Breite width		Höhe height		18/10	versilbert silver-plated
mm	in.	mm	in.	mm	in.	18/10	
162	6 ³ / ₈	83	3 ¹ / ₄	61	2 ⁹ / ₁₆	60.5496.0000	60.7496.0000

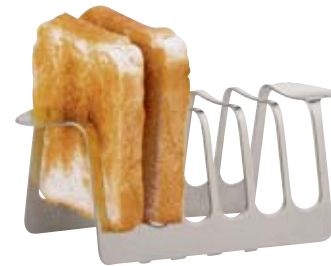

NEUTRAL

**Serviertablett, Serving tray
oval**

Länge length		Breite width		18/10	versilbert silver-plated
mm	in.	mm	in.	18/10	
221	8 ¹¹ / ₁₆	156	6 ¹ / ₈	12.2032.2300	13.3032.2300



NEUTRAL

Obstkorb, Fruit basket

Höhe height		Ø-Außen Ø-outer		18/10
mm	in.	mm	in.	18/10
84	3 ⁹ / ₁₆	205	8 ¹ / ₁₆	60.5514.2050
94	3 ¹¹ / ₁₆	255	10 ¹ / ₁₆	60.5514.2550



NEUTRAL

HEISSGETRÄNKE · HOT DRINKS



Kaffeekanne, Coffee pot

Inhalt cap.		18/10 18/10	versilbert silver-plated
Ltr.	oz.		
0,30	11	12.2102.0300	13.3102.0300
0,60	21	12.2102.0600	13.3102.0600
1,00	35	12.2102.1000	13.3102.1000
1,75	62	12.2102.1750	13.3102.1750

EXCELLENT



Teekanne, Tea pot

Inhalt cap.		18/10 18/10	versilbert silver-plated
Ltr.	oz.		
0,35	12	12.2103.0350	13.3103.0350
0,70	25	12.2103.0700	13.3103.0700

EXCELLENT



Milchkanne, Milk jug

Inhalt cap.		18/10 18/10	versilbert silver-plated
Ltr.	oz.		
0,15	5	12.2104.0150	13.3104.0150
0,30	11	12.2104.0300	13.3104.0300

EXCELLENT



Zuckerdose, Sugar bowl

Inhalt cap.		18/10 18/10	versilbert silver-plated
Ltr.	oz.		
0,25	9	12.2105.0250	13.3105.0250

EXCELLENT

Zuckerdose, Sugar bowl

Inhalt cap.		18/10	versilbert silver-plated
Ltr.	oz.		
0,20	7	12.2106.0200	13.3106.0200



NEUTRAL

Kaffeekanne, Coffee pot

Inhalt cap.		18/10	versilbert silver-plated
Ltr.	oz.		
0,30	11	12.3402.0300	15.3402.0300
0,60	21	12.3402.0600	15.3402.0600
1,00	35	12.3402.1000	15.3402.1000
1,75	62	12.3402.1750	15.3402.1750



EXCLUSIVE

Teekanne, Tea pot

Inhalt cap.		18/10	versilbert silver-plated
Ltr.	oz.		
0,35	12	12.3403.0350	15.3403.0350
0,70	25	12.3403.0700	15.3403.0700



EXCLUSIVE

Zuckerdose, Sugar bowl

Inhalt cap.		18/10	versilbert silver-plated
Ltr.	oz.		
0,25	9	12.3405.0250	15.3405.0250



EXCLUSIVE

HEISSGETRÄNKE · HOT DRINKS



Kaffeekanne, Coffee pot

Inhalt cap.		18/10	versilbert
Ltr. oz.		18/10	silver-plated
0,30	11	12.2301.0300	15.2301.0300
0,60	21	12.2301.0600	15.2301.0600
1,50	53	12.2301.1500	15.2301.1500

AVANTGARDE



Teekanne, Tea pot

Inhalt cap.		18/10	versilbert
Ltr. oz.		18/10	silver-plated
0,35	12	12.2302.0350	15.2302.0350
0,70	25	12.2302.0700	15.2302.0700

AVANTGARDE



Teekanne, Tea pot

Inhalt cap.		18/10	versilbert
Ltr. oz.		18/10	silver-plated
0,35	12	12.2307.0350	15.2307.0350
0,70	25	12.2307.0700	15.2307.0700

AVANTGARDE



Milchkanne, Milk jug

Inhalt cap.		18/10	versilbert
Ltr. oz.		18/10	silver-plated
0,15	5	12.2203.0150	13.2203.0150
0,30	11	12.2203.0300	13.2203.0300

AVANTGARDE

Kaffeekanne, Coffee pot

Inhalt cap.		18/10 18/10	versilbert silver-plated
Ltr.	oz.		
0,30	11	12.2201.0300	15.2201.0300
0,60	21	12.2201.0600	15.2201.0600
1,50	53	12.2201.1500	15.2201.1500



AVANTGARDE

Teekanne, Tea pot

Inhalt cap.		18/10 18/10	versilbert silver-plated
Ltr.	oz.		
0,35	12	12.2202.0350	15.2202.0350
0,70	25	12.2202.0700	15.2202.0700



AVANTGARDE

Zuckerdose, Sugar bowl

Inhalt cap.		18/10 18/10	versilbert silver-plated
Ltr.	oz.		
0,25	9	12.2204.0250	15.2204.0250



AVANTGARDE

Zuckerdose, Sugar bowl

Inhalt cap.		18/10 18/10	versilbert silver-plated
Ltr.	oz.		
0,25	9	12.2205.0250	13.2205.0250



AVANTGARDE

HEISSGETRÄNKE · HOT DRINKS

Zuckerdose, Sugar bowl

Inhalt cap.		18/10 18/10	versilbert silver-plated
Ltr.	oz.		
0,25	9	12.2206.0250	13.2206.0250



AVANTGARDE

Zuckerservice, Sugar server 6-tlg., 6-part

Länge length		Breite width		18/10 18/10	versilbert silver-plated
mm	in.	mm	in.		
270	10 ⁵ / ₈	200	7 ⁷ / ₈	12.2277.0000	13.2277.0000



Milchgießer, Milk jug

Inhalt cap.		18/10 18/10	versilbert silver-plated
Ltr.	oz.		
0,07	2	12.2744.0070	13.3744.0070

AVANTGARDE

Kaffeekanne, Coffee pot

Inhalt cap.		18/10 18/10	versilbert silver-plated
Ltr.	oz.		
0,30	11	12.4709.0300	13.4709.0300
0,60	21	12.4709.0600	13.4709.0600
1,50	53	12.4709.1500	13.4709.1500



TRADITION

Kaffeekanne, Coffee pot

Inhalt cap.		18/10 18/10	versilbert silver-plated
Ltr.	oz.		
0,30	11	12.4701.0300	13.4701.0300
0,60	21	12.4701.0600	13.4701.0600
1,50	53	12.4701.1500	13.4701.1500



TRADITION

Teekanne, Tea pot

Inhalt cap.		18/10	versilbert
		18/10	silver-plated
Ltr.	oz.		
0,35	12	12.4707.0350	13.4707.0350
0,70	25	12.4707.0700	13.4707.0700



TRADITION

Milchkanne, Milk jug

Inhalt cap.		18/10	versilbert
		18/10	silver-plated
Ltr.	oz.		
0,15	5	12.4603.0150	13.4603.0150
0,30	11	12.4603.0300	13.4603.0300



TRADITION

Zuckerdose, Sugar bowl

Inhalt cap.		18/10	versilbert
		18/10	silver-plated
Ltr.	oz.		
0,25	9	12.4604.0250	13.4604.0250



TRADITION

Kaffeekanne, Coffee pot

Inhalt cap.		18/10	versilbert
		18/10	silver-plated
Ltr.	oz.		
0,30	11	12.4402.0300	13.4402.0300
0,60	21	12.4402.0600	13.4402.0600
1,00	35	12.4402.1000	13.4402.1000
2,00	70	12.4402.2000	13.4402.2000



PROFILE

HEISSGETRÄNKE · HOT DRINKS



Teekanne, Tea pot

Inhalt cap.		18/10	versilbert
Ltr.		18/10	silver-plated
0,35	12	12.4403.0350	13.4403.0350
0,70	25	12.4403.0700	13.4403.0700

PROFILE



Milchkanne, Milk jug

Inhalt cap.		18/10	versilbert
Ltr.		18/10	silver-plated
0,15	5	12.4404.0150	13.4404.0150
0,30	11	12.4404.0300	13.4404.0300
0,60	21	12.4404.0600	13.4404.0600

PROFILE



Zuckerdose, Sugar bowl

Inhalt cap.		18/10	versilbert
Ltr.		18/10	silver-plated
0,25	9	12.4405.0250	13.4405.0250

PROFILE



Kaffeekanne, Coffee pot

Inhalt cap.		18/10	versilbert
Ltr.		18/10	silver-plated
0,30	11	12.5225.0300	13.5225.0300
0,60	21	12.5225.0600	13.5225.0600
1,00	35	12.5225.1000	13.5225.1000
2,00	70	12.5225.2000	13.5225.2000

ARTE

Teekanne, Tee pot

Inhalt cap.		18/10 18/10	versilbert silver-plated
Ltr.	oz.		
0,35	12	12.5226.0350	13.5226.0350
0,70	25	12.5226.0700	13.5226.0700



ARTE

Milchkanne, Milk jug

Inhalt cap.		18/10 18/10	versilbert silver-plated
Ltr.	oz.		
0,15	5	12.5227.0150	13.5227.0150
0,30	11	12.5227.0300	13.5227.0300
0,60	21	12.5227.0600	13.5227.0600



ARTE

Zuckerdose, sugar bowl

Inhalt cap.		18/10 18/10	versilbert silver-plated
Ltr.	oz.		
0,25	9	12.5228.0250	13.5228.0250



ARTE

Kaffeekanne, Coffee pot
doppelwandig, double-walled

Inhalt cap.		18/10 18/10
Ltr.	oz.	
0,30	11	60.5330.0300
0,60	21	60.5330.0600
1,20	42	60.5330.1200



NEUTRAL

HEISSGETRÄNKE · HOT DRINKS

Teekanne, Tea pot
 doppelwandig, double-walled
 mit Teesieb
 with tea strainer



Inhalt cap.		18/10 18/10
Ltr.	oz.	
0,60	21	60.5329.0600
1,20	42	60.5329.1200

NEUTRAL

Milchkanne, Milk jug
 doppelwandig, double-walled



Inhalt cap.		18/10 18/10
Ltr.	oz.	
0,15	5	60.5330.0150

doppelwandig, ohne Deckel, double-walled, without lid

Inhalt cap.		18/10 18/10
Ltr.	oz.	
0,30	11	60.5327.0300

NEUTRAL

Zuckerdose, Sugar bowl
 für sticks, for sticks



Höhe height		Ø-Außen Ø-outer		18/10 18/10
mm	in.	mm	in.	
80	3 ¹ / ₈	50	1 ¹⁵ / ₁₆	60.5306.0150

NEUTRAL

Zuckerbox, Sugar box
 rechteckig, rectangular



Länge length		Höhe height		Tiefe depth		18/10 18/10
mm	in.	mm	in.	mm	in.	
110	24 ¹⁰ / ₁₆	45	11 ² / ₁₆	40	1 ⁹ / ₁₆	60.5060.0000

NEUTRAL

Isolierkanne, Insulated beverage server

Inhalt cap.		18/10 18/10	
Ltr.	oz.		
0,30	11	60.8899.0300	
0,60	21	60.8899.0600	
1,10	39	60.8899.1100	
1,40	49	60.8899.1500	



NEUTRAL

Isolierkanne, Insulated beverage server

Inhalt cap.		18/10 18/10	
Ltr.	oz.		
0,35	12	60.5499.0350	
0,60	21	60.5499.0600	
1,00	35	60.5499.1000	
1,40	49	60.5499.1400	



NEUTRAL

Zitronenpresse, Lemon squeezer

Länge length		Breite width		18/10 18/10	versilbert silver-plated
mm	in.	mm	in.		
82	3 ¹ / ₄	69	2 ¹¹ / ₁₆	60.8828.0000	60.9028.0000



NEUTRAL

Teesieb, Tea strainer
mit Abstellschale, with drip stand

Länge length		Breite width		Höhe height		18/10 18/10	versilbert silver-plated
mm	in.	mm	in.	mm	in.		
168	6 ⁵ / ₈	67	2 ⁵ / ₈	26	1	12.2038.0000	13.3038.0000



NEUTRAL

HEISSGETRÄNKE · HOT DRINKS



Irish Coffee-Wärmer, Irish Coffee warmer

Länge length		Breite width		Höhe height		18/10 18/10	versilbert silver-plated
mm	in.	mm	in.	mm	in.		
165	6½	73	2⅞	180	7⅛	60.8805.0000	60.9005.0000

NEUTRAL



Teeglashalter, Tea glass holder

Inhalt cap.		Höhe height		18/10 18/10	versilbert silver-plated
Ltr.	oz.	mm	in.		
0,20	7	91	3⅞	12.2379.0000	13.2379.0000

NEUTRAL



Zuckerständer, Sugar server
3-tlg., 3-part

Höhe height		18/10 18/10	versilbert silver-plated
mm	in.		
183	7⅞	12.2250.0000	15.2250.0000

EXCELLENT



Zuckerständer, Sugar server
4-tlg., für Milch und Zucker, 4-part, for milk and sugar

Höhe height		18/10 18/10	versilbert silver-plated
mm	in.		
183	7⅞	12.2265.0000	15.2265.0000

EXCELLENT

Zuckerständer, Sugar server
5-tlg., für Milch und Zucker, 5-part, for milk and sugar

Höhe height	18/10	versilbert silver-plated
mm	in.	
245	9 ⁵ / ₈	12.2350.0000 15.2350.0000



EXCELLENT

Zuckerständer, Sugar server
mit Glaseinsatz, with glass insert

Höhe height	18/10	versilbert silver-plated
mm	in.	
140	5 ¹ / ₂	12.2351.0700 15.2351.0700



EXCELLENT

Zuckerständer, Sugar server

Höhe height	18/10	versilbert silver-plated
mm	in.	
112	4 ⁷ / ₁₆	12.4052.0650 15.4552.0650
146	5 ³ / ₄	12.4052.0900 15.4552.0900



EXCELLENT

Zuckerständer, Sugar server
5-tlg., für Milch und Zucker, 5-part, for milk and sugar

Höhe height	18/10	versilbert silver-plated
mm	in.	
142	5 ⁹ / ₁₆	12.4866.0000 15.4866.0000



PROFILE

HEISSGETRÄNKE · HOT DRINKS

Zuckerständer, Sugar server
mit Glaseinsatz, with glass insert



Höhe height		18/10	versilbert silver-plated
mm	in.	18/10	
137	5 ³ / ₈	12.4851.0700	15.4851.0700

PROFILE

Zuckerständer, Sugar server



Höhe height		18/10	versilbert silver-plated
mm	in.	18/10	
109	4 ⁵ / ₁₆	12.4852.0650	15.4852.0650
141	5 ⁹ / ₁₆	12.4852.0900	15.4852.0900

PROFILE

Zuckerständer, Sugar server



Höhe height		18/10	versilbert silver-plated
mm	in.	18/10	
111	4 ³ / ₈	12.3452.0650	15.3452.0650
145	5 ¹¹ / ₁₆	12.3452.0900	15.3452.0900

EXCLUSIVE

Zuckerständer, Sugar server
5-tlg., 5-part



Höhe height		18/10	versilbert silver-plated
mm	in.	18/10	
142	5 ⁹ / ₁₆	12.5266.0000	15.5266.0000

ARTE

Zuckersständer, Sugar server
3-tlg., 3-part
mit Einsätzen
with insert

Höhe height		18/10	versilbert silver-plated
mm	in.		
137	5 ³ / ₈	12.5251.0700	15.5251.0700



ARTE

Zuckersständer, Sugar server

Höhe height		18/10	versilbert silver-plated
mm	in.		
109	4 ⁵ / ₁₆	12.5252.0650	15.5252.0650
141	5 ⁹ / ₁₆	12.5252.0900	15.5252.0900



ARTE

Ständer für Konfitürengläser, Stand for jam glasses
3-tlg., 3-part

Höhe height		18/10	versilbert silver-plated
mm	in.		
113	4 ⁷ / ₁₆	12.3461.0000	15.3461.0000



EXCLUSIVE

Ständer für Konfitürengläser, Stand for jam glasses
3-tlg., 3-part

Höhe height		18/10	versilbert silver-plated
mm	in.		
105	4 ¹ / ₈	12.4861.0000	15.4861.0000



PROFILE

HEISSGETRÄNKE · HOT DRINKS



Ständer für Konfitüregläser, Stand for jam glasses
3-tlg., 3-part

Höhe height		18/10 18/10	versilbert silver-plated
mm	in.		
115	4½	12.4161.0000	15.5161.0000

EXCELLENT



Ständer für Konfitüregläser, Stand for jam glasses
5-tlg, mit Vase, 5-part, with vase

Höhe height		18/10 18/10	versilbert silver-plated
mm	in.		
200	7⅞	12.2144.0000	13.5144.0000

NEUTRAL



Honig-Konfitürendose, Jam/honey pot
3-tlg., 3-part

Höhe height		18/10 18/10	versilbert silver-plated
mm	in.		
140	5½	12.2258.0700	15.2258.0700

EXCELLENT



Honig-Konfitürendose, Jam/honey pot
3-tlg., 3-part

Höhe height		18/10 18/10	versilbert silver-plated
mm	in.		
134	5¼	12.4958.0700	15.4958.0700

PROFILE

Gebäckständer, Pastry stand

Höhe height		Ø-Außen Ø-outer		18/10 18/10	versilbert silver-plated
mm	in.	mm	in.		
94	3 ¹¹ / ₁₆	121	4 ³ / ₄	12.2268.1200	15.2268.1200
97	3 ¹³ / ₁₆	162	6 ³ / ₈	12.2268.1600	15.2268.1600
118	4 ⁵ / ₈	213	8 ³ / ₈	12.2268.2100	15.2268.2100



EXCELLENT

Gebäckständer, Pastry stand 2-tlg., 2-part

Höhe height		Ø-Außen Ø-outer		18/10 18/10	versilbert silver-plated
mm	in.	mm	in.		
231	9 ¹ / ₈	160	6 ⁵ / ₁₆	12.2172.1620	15.5172.1620
241	9 ¹ / ₂	209	8 ¹ / ₄	12.2172.2120	15.5172.2120



TRADITION

Gebäckständer, Pastry stand 2-tlg., 2-part

Höhe height		Ø-Außen Ø-outer		18/10 18/10	versilbert silver-plated
mm	in.	mm	in.		
223	8 ³ / ₄	160	6 ⁵ / ₁₆	12.2269.1620	15.2269.1620
224	8 ¹³ / ₁₆	215	8 ⁷ / ₁₆	12.2269.2120	15.2269.2120



EXCELLENT

Gebäckständer, Pastry stand 3-tlg., 3-part

Höhe height		Ø-Außen Ø-outer		18/10 18/10	versilbert silver-plated
mm	in.	mm	in.		
320	12 ⁵ / ₈	215	8 ⁷ / ₁₆	12.2269.2130	15.2269.2130



EXCELLENT

GEBÄCK · CAKES AND BISQUITS



Gebäckständer, Pastry stand
2-tlg., 2-part

Höhe height		Ø-Außen Ø-outer		18/10 18/10	versilbert silver-plated
mm	in.	mm	in.		
230	9 ¹ / ₁₆	162	6 ³ / ₈	12.3469.1620	15.3469.1620
230	9 ¹ / ₁₆	216	8 ¹ / ₂	12.3469.2120	15.3469.2120

EXCLUSIVE



Gebäckständer, Pastry stand
3-tlg., 3-part

Höhe height		Ø-Außen Ø-outer		18/10 18/10	versilbert silver-plated
mm	in.	mm	in.		
320	12 ⁵ / ₈	216	8 ¹ / ₂	12.3469.2130	15.3469.2130

EXCLUSIVE



Gebäckständer, Pastry stand
2-tlg., 2-part

Höhe height		Ø-Außen Ø-outer		18/10 18/10	versilbert silver-plated
mm	in.	mm	in.		
220	8 ¹¹ / ₁₆	162	6 ³ / ₈	12.4869.1620	15.4869.1620
221	8 ¹¹ / ₁₆	216	8 ¹ / ₂	12.4869.2120	15.4869.2120

PROFILE



Gebäckständer, Pastry stand
3-tlg., 3-part

Höhe height		Ø-Außen Ø-outer		18/10 18/10	versilbert silver-plated
mm	in.	mm	in.		
312	12 ⁵ / ₁₆	216	8 ¹ / ₂	12.4869.2130	15.4869.2130

PROFILE

Gebäckständer, Pastry stand

Höhe height		18/10 18/10	versilbert silver-plated
mm	in.		
160	10/16	12.5268.1600	13.5268.1600



ARTE

Gebäckständer, Pastry stand 3-tlg., 3-part

Höhe height		Ø-Außen Ø-outer		18/10 18/10	versilbert silver-plated
mm	in.	mm	in.		
220	8 ¹¹ / ₁₆	216	8 ¹ / ₂	12.5269.2120	15.5269.2120



ARTE

Tortenplatte, Cake plate

Höhe height		Ø-Außen Ø-outer		18/10 18/10
mm	in.	mm	in.	
40	1 ⁹ / ₁₆	310	12 ³ / ₁₆	60.8906.3000



NEUTRAL

Tortenmesser, Cake knife

Länge length		18/10 18/10
mm	in.	
293	11 ⁹ / ₁₆	60.5444.0000



NEUTRAL

GEBÄCK · CAKES AND BISQUITS

Tortmesserbehälter, Cake knife stand

Höhe height		18/10 18/10
mm	in.	
193	7 ⁵ / ₈	60.5445.0000



NEUTRAL

Universalständer, Multi purpose stand
für Teller Ø 21 cm, for plate Ø 8¹/₄ inch

Breite width		Höhe height		18/10 18/10	versilbert silver-plated
mm	in.	mm	in.		
245	9 ⁵ / ₈	411	16 ³ / ₁₆	12.2078.0000	13.3078.0000



für Teller Ø 24 cm, for plate Ø 9⁷/₁₆ inch

Breite width		Höhe height		18/10 18/10	versilbert silver-plated
mm	in.	mm	in.		
290	11 ⁷ / ₁₆	400	15 ³ / ₄	12.2078.2400	13.3078.2400

NEUTRAL

Universalständer, Multi purpose stand
für Teller Ø 21 cm, for plate Ø 8¹/₄ inch

Breite width		Höhe height		18/10 18/10	versilbert silver-plated
mm	in.	mm	in.		
324	12 ³ / ₄	447	17 ⁵ / ₈	12.4178.0000	13.5178.0000



EXCELLENT



Servieren wird zum 5-Sterne Erlebnis

In der Königsklasse der internationalen Spitzengastronomie gehören Produkte aus dem Hause HEPP schon zur Selbstverständlichkeit, denn nirgendwo sonst herrscht ein vergleichbarer Anspruch auf Qualität. Mit unseren formschönen Serviergeräten werden klassische Menüs und Banketts zum glanzvollen Erlebnis. Unvergleichliches Design und die Liebe zum Detail verschaffen unseren Produkten einen unverwechselbaren Charakter. So wird jeder kulinarische Genuss und jede bravouröse Veranstaltung zu einer individuellen und sinnlichen Attraktion.

Serving turns into a 5-star experience

In the champion's league of the top international catering trade HEPP articles are found as a matter of course, for there is no comparable aspiration to quality anywhere else. Our attractively designed hollowware make classical menus and banquets a brilliant experience. Incomparable design and a love of details give our products an unmistakable character. HEPP makes every culinary treat and each outstanding event an individualized and sensual attraction.

MENÜ & BANKETT · MENU & BANQUET



MENÜ & BANKETT · MENU & BANQUET

Platzteller, Service plate

Ø-Außen Ø-outer		Ø-Innen Ø-inner		18/10 18/10	versilbert silver-plated
mm	in.	mm	in.		
309	12 ³ / ₁₆	180	7 ¹ / ₁₆	12.2099.3000	13.3099.3000
331	13 ¹ / ₁₆	200	7 ⁷ / ₈	12.2099.3300	13.3099.3300



EXCELLENT

Platzteller, Service plate

Ø-Außen Ø-outer		Ø-Innen Ø-inner		18/10 18/10	versilbert silver-plated
mm	in.	mm	in.		
330	13	205	8 ¹ / ₁₆	12.2088.3300	13.3088.3300



PROFILE

Platzteller, Service plate

Ø-Außen Ø-outer		Ø-Innen Ø-inner		18/10 18/10	versilbert silver-plated
mm	in.	mm	in.		
330	13	205	8 ¹ / ₁₆	12.2123.3300	13.3123.3300



EXCELLENT

Kugelglocke, Dome cover

Höhe height		Ø-Außen Ø-outer		18/10 18/10	versilbert silver-plated
mm	in.	mm	in.		
68	2 ¹¹ / ₁₆	121	4 ³ / ₄	12.3104.1200	15.3104.1200
78	3 ¹ / ₁₆	160	6 ⁵ / ₁₆	12.3104.1600	15.3104.1600
138	5 ⁷ / ₁₆	210	8 ¹ / ₄	12.3104.2100	15.3104.2100
151	5 ¹⁵ / ₁₆	228	9	12.3104.2250	15.3104.2250
164	6 ⁷ / ₁₆	242	9 ¹ / ₂	12.3104.2400	15.3104.2400
182	7 ³ / ₁₆	272	10 ¹¹ / ₁₆	12.3104.2700	15.3104.2700
275	10 ¹³ / ₁₆	386	15 ³ / ₁₆	12.3104.3700	15.3104.3700



EXCLUSIVE

Kugelglocke, Dome cover

Höhe height		Ø-Außen Ø-outer		18/10 18/10	versilbert silver-plated
mm	in.	mm	in.		
64	2 ¹ / ₂	121	4 ³ / ₄	12.3105.1200	15.3105.1200
87	3 ⁷ / ₁₆	160	6 ⁵ / ₁₆	12.3105.1600	15.3105.1600
130	5 ¹ / ₈	210	8 ¹ / ₄	12.3105.2100	15.3105.2100
141	5 ⁹ / ₁₆	228	9	12.3105.2250	15.3105.2250
153	6	242	9 ¹ / ₂	12.3105.2400	15.3105.2400
165	6 ¹ / ₂	272	10 ¹¹ / ₁₆	12.3105.2700	15.3105.2700
242	9 ¹ / ₂	386	15 ³ / ₁₆	12.3105.3700	15.3105.3700



PROFILE

Kugelglocke, Dome cover

Höhe height		Ø-Außen Ø-outer		18/10 18/10	versilbert silver-plated
mm	in.	mm	in.		
64	2 ¹ / ₂	121	4 ³ / ₄	12.3102.1200	15.3102.1200
83	3 ¹ / ₄	160	6 ⁵ / ₁₆	12.3102.1600	15.3102.1600
124	4 ⁷ / ₈	210	8 ¹ / ₄	12.3102.2100	15.3102.2100
148	5 ¹³ / ₁₆	228	9	12.3102.2250	15.3102.2250
143	5 ⁵ / ₈	242	9 ¹ / ₂	12.3102.2400	15.3102.2400
157	6 ³ / ₁₆	272	10 ¹¹ / ₁₆	12.3102.2700	15.3102.2700
235	9 ¹ / ₄	386	15 ³ / ₁₆	12.3102.3700	15.3102.3700



EXCELLENT

MENÜ & BANKETT · MENU & BANQUET



Kugelglocke, Dome cover

Höhe height		Ø-Außen Ø-outer		18/10 18/10	versilbert silver-plated
mm	in.	mm	in.		
64	2 ¹ / ₂	121	4 ³ / ₄	12.3106.1200	15.3106.1200
87	3 ⁷ / ₁₆	160	6 ⁵ / ₁₆	12.3106.1600	15.3106.1600
130	5 ¹ / ₈	210	8 ¹ / ₄	12.3106.2100	15.3106.2100
141	5 ⁹ / ₁₆	228	9	12.3106.2250	15.3106.2250
153	6	242	9 ¹ / ₂	12.3106.2400	15.3106.2400
165	6 ¹ / ₂	272	10 ¹¹ / ₁₆	12.3106.2700	15.3106.2700
242	9 ¹ / ₂	386	15 ³ / ₁₆	12.3106.3700	15.3106.3700

ARTE

Gemüseschüssel, Vegetable dish

Inhalt cap.		Ø-Außen Ø-outer		18/10 18/10	versilbert silver-plated
Ltr.	oz.	mm	in.		
0,20	7	110	4 ⁵ / ₁₆	12.4008.1100	15.4508.1100
0,30	11	130	5 ¹ / ₈	12.4008.1300	15.4508.1300
0,50	18	157	6 ³ / ₁₆	12.4008.1600	15.4508.1600
0,90	32	190	7 ¹ / ₂	12.4008.1900	15.4508.1900
1,50	53	222	8 ³ / ₄	12.4008.2200	15.4508.2200
2,00	70	250	9 ¹³ / ₁₆	12.4008.2400	15.4508.2400

Deckel, Lid

Ø-Außen Ø-outer		18/10 18/10	versilbert silver-plated
mm	in.		
113	4 ⁷ / ₁₆	12.2211.1100	15.2211.1100
128	5 ¹ / ₁₆	12.2211.1300	15.2211.1300
158	6 ¹ / ₄	12.2211.1600	15.2211.1600
189	7 ⁷ / ₁₆	12.2211.1900	15.2211.1900
220	8 ¹ / ₁₆	12.2211.2200	15.2211.2200
256	10 ¹ / ₁₆	12.2211.2400	15.2211.2400



EXCELLENT

Servierschüssel, Serving dish oval

Inhalt cap.		Länge length		Breite width		18/10 18/10	versilbert silver-plated
Ltr.	oz.	mm	in.	mm	in.		
0,60	21	263	10 ³ / ₈	159	6 ¹ / ₄	12.4000.2600	15.4500.2600
0,90	32	308	12 ¹ / ₈	176	6 ¹⁵ / ₁₆	12.4000.3050	15.4500.3050
1,40	49	351	13 ¹³ / ₁₆	200	7 ⁷ / ₈	12.4000.3400	15.4500.3400
2,00	70	417	16 ⁷ / ₁₆	235	9 ¹ / ₄	12.4000.4000	15.4500.4000

Deckel, Lid oval

Länge length		Breite width		18/10 18/10	versilbert silver-plated
mm	in.	mm	in.		
265	10 ⁷ / ₁₆	160	6 ⁵ / ₁₆	12.2503.2600	15.2503.2600
316	12 ⁷ / ₁₆	187	7 ³ / ₈	12.2503.3050	15.2503.3050
354	13 ¹³ / ₁₆	203	8	12.2503.3400	15.2503.3400
423	16 ⁵ / ₈	246	9 ¹¹ / ₁₆	12.2503.4000	15.2503.4000



EXCELLENT

Suppenschüssel, Soup tureen

Inhalt cap.		Ø-Außen Ø-outer		18/10	versilbert silver-plated
Ltr.	oz.	mm	in.	18/10	18/10
0,70	25	170	6 ¹¹ / ₁₆	12.2248.1600	15.2248.1600
2,00	70	218	8 ⁹ / ₁₆	12.2248.2100	15.2248.2100
3,00	106	248	9 ⁹ / ₄	12.2248.2400	15.2248.2400
4,50	158	285	11 ¹ / ₄	12.2248.2700	15.2248.2700

Deckel mit Einschnitt, Lid with hole

Ø-Außen Ø-outer		18/10	versilbert silver-plated
mm	in.	18/10	18/10
177	6 ¹⁵ / ₁₆	12.2249.1600	15.2249.1600
222	8 ³ / ₄	12.2249.2100	15.2249.2100
256	10 ¹ / ₁₆	12.2249.2400	15.2249.2400
290	11 ⁷ / ₁₆	12.2249.2700	15.2249.2700



EXCELLENT

Gemüseschüssel, Vegetable dish

Inhalt cap.		Ø-Außen Ø-outer		18/10	versilbert silver-plated
Ltr.	oz.	mm	in.	18/10	18/10
0,20	7	110	4 ⁵ / ₁₆	12.4808.1100	15.4808.1100
0,30	11	130	5 ¹ / ₈	12.4808.1300	15.4808.1300
0,50	18	157	6 ³ / ₁₆	12.4808.1600	15.4808.1600
0,90	32	190	7 ¹ / ₂	12.4808.1900	15.4808.1900
1,50	53	222	8 ³ / ₄	12.4808.2200	15.4808.2200
2,00	70	250	9 ¹³ / ₁₆	12.4808.2400	15.4808.2400

Deckel, Lid

Ø-Außen Ø-outer		18/10	versilbert silver-plated
mm	in.	18/10	18/10
113	4 ⁷ / ₁₆	12.4811.1100	15.4811.1100
128	5 ¹ / ₁₆	12.4811.1300	15.4811.1300
158	6 ¹ / ₄	12.4811.1600	15.4811.1600
189	7 ⁷ / ₁₆	12.4811.1900	15.4811.1900
220	8 ¹ / ₁₆	12.4811.2200	15.4811.2200
256	10 ¹ / ₁₆	12.4811.2400	15.4811.2400



PROFILE

Servierschüssel, Serving dish oval

Inhalt cap.		Länge length		Breite width		18/10	versilbert silver-plated
Ltr.	oz.	mm	in.	mm	in.	18/10	18/10
0,60	21	263	10 ³ / ₈	159	6 ¹ / ₄	12.4800.2600	15.4800.2600
0,90	32	308	12 ¹ / ₈	176	6 ¹⁵ / ₁₆	12.4800.3050	15.4800.3050
1,40	49	351	13 ¹³ / ₁₆	200	7 ⁷ / ₈	12.4800.3400	15.4800.3400
2,00	70	417	16 ⁷ / ₁₆	235	9 ¹ / ₄	12.4800.4000	15.4800.4000

Deckel, Lid oval

Länge length		Breite width		18/10	versilbert silver-plated
mm	in.	mm	in.	18/10	18/10
265	10 ⁷ / ₁₆	160	6 ⁵ / ₁₆	12.4803.2600	15.4803.2600
316	12 ⁷ / ₁₆	187	7 ³ / ₈	12.4803.3050	15.4803.3050
354	13 ¹³ / ₁₆	203	8	12.4803.3400	15.4803.3400
423	16 ⁵ / ₈	246	9 ¹¹ / ₁₆	12.4803.4000	15.4803.4000



PROFILE

MENÜ & BANKETT · MENU & BANQUET

Suppenschüssel, Soup tureen

Inhalt cap.		Ø-Außen Ø-outer		18/10 18/10	versilbert silver-plated
Ltr.	oz.	mm	in.		
0,70	25	170	6 ¹¹ / ₁₆	12.4848.1600	15.4848.1600
2,00	70	218	8 ⁹ / ₁₆	12.4848.2100	15.4848.2100
3,00	106	248	9 ⁹ / ₄	12.4848.2400	15.4848.2400
4,50	158	285	11 ¹ / ₄	12.4848.2700	15.4848.2700



Deckel mit Einschnitt, Lid with hole

Ø-Außen Ø-outer		18/10 18/10	versilbert silver-plated
mm	in.		
177	6 ¹⁵ / ₁₆	12.4849.1600	15.4849.1600
222	8 ³ / ₄	12.4849.2100	15.4849.2100
256	10 ¹ / ₁₆	12.4849.2400	15.4849.2400
290	11 ⁷ / ₁₆	12.4849.2700	15.4849.2700

PROFILE

Gemüseschüssel, Vegetable dish

Inhalt cap.		Ø-Außen Ø-outer		18/10 18/10	versilbert silver-plated
Ltr.	oz.	mm	in.		
0,20	7	110	4 ⁵ / ₁₆	12.4008.1100	15.4508.1100
0,30	11	130	5 ¹ / ₈	12.4008.1300	15.4508.1300
0,50	18	157	6 ³ / ₁₆	12.4008.1600	15.4508.1600
0,90	32	190	7 ¹ / ₂	12.4008.1900	15.4508.1900
1,50	53	222	8 ³ / ₄	12.4008.2200	15.4508.2200
2,00	70	250	9 ¹³ / ₁₆	12.4008.2400	15.4508.2400

Deckel, Lid

Ø-Außen Ø-outer		18/10 18/10	versilbert silver-plated
mm	in.		
113	4 ⁷ / ₁₆	12.3411.1100	15.3411.1100
128	5 ¹ / ₁₆	12.3411.1300	15.3411.1300
158	6 ¹ / ₄	12.3411.1600	15.3411.1600
189	7 ⁷ / ₁₆	12.3411.1900	15.3411.1900
220	8 ¹ / ₁₆	12.3411.2200	15.3411.2200
256	10 ¹ / ₁₆	12.3411.2400	15.3411.2400



EXCLUSIVE

Servierschüssel, Serving dish oval

Inhalt cap.		Länge length		Breite width		18/10 18/10	versilbert silver-plated
Ltr.	oz.	mm	in.	mm	in.		
0,60	21	263	10 ³ / ₈	159	6 ¹ / ₄	12.4000.2600	15.4500.2600
0,90	32	308	12 ¹ / ₈	176	6 ¹⁵ / ₁₆	12.4000.3050	15.4500.3050
1,40	49	351	13 ¹³ / ₁₆	200	7 ⁷ / ₈	12.4000.3400	15.4500.3400
2,00	70	417	16 ⁷ / ₁₆	235	9 ¹ / ₄	12.4000.4000	15.4500.4000

Deckel, Lid oval

Länge length		Breite width		18/10 18/10	versilbert silver-plated
mm	in.	mm	in.		
265	10 ⁷ / ₁₆	160	6 ⁵ / ₁₆	12.3503.2600	15.3503.2600
316	12 ⁷ / ₁₆	187	7 ³ / ₈	12.3503.3050	15.3503.3050
354	13 ¹³ / ₁₆	203	8	12.3503.3400	15.3503.3400
423	16 ⁵ / ₈	246	9 ¹¹ / ₁₆	12.3503.4000	15.3503.4000



EXCLUSIVE

Suppenschüssel, Soup tureen

Inhalt cap.		Ø-Außen Ø-outer		18/10 18/10	versilbert silver-plated
Ltr.	oz.	mm	in.		
0,70	25	170	6 ¹¹ / ₁₆	12.2248.1600	15.2248.1600
2,00	70	218	8 ⁹ / ₁₆	12.2248.2100	15.2248.2100
3,00	106	248	9 ³ / ₄	12.2248.2400	15.2248.2400
4,50	158	285	11 ¹ / ₄	12.2248.2700	15.2248.2700

Deckel mit Einschnitt, Lid with hole

Ø-Außen Ø-outer		18/10 18/10	versilbert silver-plated
mm	in.		
177	6 ¹⁵ / ₁₆	12.3449.1600	15.3449.1600
222	8 ³ / ₄	12.3449.2100	15.3449.2100
256	10 ¹ / ₁₆	12.3449.2400	15.3449.2400
290	11 ⁷ / ₁₆	12.3449.2700	15.3449.2700



EXCLUSIVE

Sauciere, Sauce boat

Inhalt cap.		18/10 18/10	versilbert silver-plated
Ltr.	oz.		
0,10	4	12.2316.0100	13.2316.0100
0,20	7	12.2316.0200	13.2316.0200
0,30	11	12.2316.0300	13.2316.0300
0,45	16	12.2316.0450	13.2316.0450



EXCELLENT

Sauciere, Sauce boat

Inhalt cap.		18/10 18/10	versilbert silver-plated
Ltr.	oz.		
0,10	4	12.2215.0100	13.2215.0100
0,20	7	12.2215.0200	13.2215.0200
0,30	11	12.2215.0300	13.2215.0300
0,45	16	12.2215.0450	13.2215.0450



EXCELLENT

MENÜ & BANKETT · MENU & BANQUET

Sauciere, Sauce boat

Inhalt cap.		18/10 18/10	versilbert silver-plated
Ltr.	oz.		
0,10	4	12.4816.0100	13.4816.0100
0,20	7	12.4816.0200	13.4816.0200
0,30	11	12.4816.0300	13.4816.0300
0,45	16	12.4816.0450	13.4816.0450



PROFILE

Sauciere, Sauce boat

Inhalt cap.		18/10 18/10	versilbert silver-plated
Ltr.	oz.		
0,10	4	12.5216.0100	13.5216.0100
0,20	7	12.5216.0200	13.5216.0200
0,30	11	12.5216.0300	13.5216.0300
0,45	16	12.5216.0450	13.5216.0450



ARTE

Servierplatte, Serving platter oval

Länge length		Breite width		18/10 18/10	versilbert silver-plated
mm	in.	mm	in.		
294	11 ⁹ / ₁₆	210	8 ¹ / ₄	60.8902.2900	60.9102.2900
376	14 ¹³ / ₁₆	256	10 ¹ / ₁₆	60.8902.3700	60.9102.3700
421	16 ⁹ / ₁₆	286	11 ¹ / ₄	60.8902.4200	60.9102.4200
476	18 ³ / ₄	313	12 ⁵ / ₁₆	60.8902.4700	60.9102.4700
581	22 ⁷ / ₈	375	14 ³ / ₄	60.8902.5800	60.9102.5800
632	24 ⁷ / ₈	401	15 ¹³ / ₁₆	60.8902.6350	60.9102.6350



NEUTRAL

Speiseglocke, Cover for serving platter oval

Länge length		Breite width		18/10 18/10	versilbert silver-plated
mm	in.	mm	in.		
329	12 ¹⁵ / ₁₆	212	8 ³ / ₈	60.8903.3200	60.9103.3200
383	15 ¹ / ₁₆	254	10	60.8903.3700	60.9103.3700
432	17	277	10 ⁷ / ₈	60.8903.4100	60.9103.4100
478	18 ¹³ / ₁₆	296	11 ⁵ / ₈	60.8903.4500	60.9103.4500



NEUTRAL

Servierplatte, Serving platter
rund, round

Ø-Außen Ø-outer		18/10	versilbert silver-plated
mm	in.		
268	10 ⁹ / ₁₆	60.8904.2650	60.9104.2650
296	11 ⁵ / ₈	60.8904.2900	60.9104.2900
319	12 ⁹ / ₁₆	60.8904.3200	60.9104.3200
373	14 ¹ / ₁₆	60.8904.3700	60.9104.3700



NEUTRAL

Fischplatte, Fish platter

Länge length		Breite width		18/10	versilbert silver-plated
mm	in.	mm	in.	18/10	
560	22 ¹ / ₁₆	245	9 ⁷ / ₈	12.2002.5500	13.3002.5500
711	28	285	11 ¹ / ₄	12.2002.7000	13.3002.7000



NEUTRAL

Servierpfanne, Service pan
oval

Länge length		Breite width		18/10 Messing 18/10 brass	versilbert silver-plated
mm	in.	mm	in.		
262	10 ⁵ / ₁₆	159	6 ¹ / ₄	14.4001.2600	15.4501.2600
308	12 ¹ / ₈	176	6 ¹⁵ / ₁₆	14.4001.3050	15.4501.3050
350	13 ³ / ₄	200	7 ⁷ / ₈	14.4001.3400	15.4501.3400



NEUTRAL

Servierpfanne, Service pan
rund, round

Inhalt cap.		Ø-Außen Ø-outer		18/10 Messing 18/10 brass	versilbert silver-plated
Ltr.	oz.	mm	in.		
2,50	88	333	13 ¹ / ₈	14.4005.3200	15.4505.3200



NEUTRAL

MENÜ & BANKETT · MENU & BANQUET

Speisewärmer, Rechaud

Länge length		Breite width		vernickelt nickel-plated	versilbert silver-plated
mm	in.	mm	in.		
292	11½	179	7 ¹ / ₁₆	60.5440.0000	60.8440.0000



NEUTRAL

Stövchen, Rechaud

Ø-Außen Ø-outer		vernickelt nickel-plated	versilbert silver-plated
mm	in.		
156	6 ¹ / ₈	60.5441.0000	60.8441.0000



NEUTRAL

Butterdose, Butter dish 4-tlg., 4-part

Höhe height		Ø-Außen Ø-outer		18/10 18/10	versilbert silver-plated
mm	in.	mm	in.		
94	3 ¹¹ / ₁₆	159	6 ¹ / ₄	12.2232.0000	15.2232.0000

2-tlg., 2-part

Höhe height		Ø-Außen Ø-outer		18/10 18/10	versilbert silver-plated
mm	in.	mm	in.		
41	1 ⁵ / ₈	116	4 ⁹ / ₁₆	12.2117.0000	13.3117.0000

Kugelglocke, Dome cover

Höhe height		Ø-Außen Ø-outer		18/10 18/10	versilbert silver-plated
mm	in.	mm	in.		
82	3 ¹ / ₄	135	5 ⁵ / ₁₆	12.3100.1350	15.3100.1350



Unterteller, Underliner

Ø-Außen Ø-outer		18/10 18/10	versilbert silver-plated
mm	in.		
159	6 ¹ / ₄	12.2024.1600	13.3024.1600

EXCELLENT

Butterdose, Butter dish
4-tlg., 4-part

Höhe height		Ø-Außen Ø-outer		18/10 18/10	versilbert silver-plated
mm	in.	mm	in.		
89	3½	159	6¼	12.4832.0000	15.4832.0000

2-tlg., 2-part

Höhe height		Ø-Außen Ø-outer		18/10 18/10	versilbert silver-plated
mm	in.	mm	in.		
41	1⅝	116	4⅞	12.2117.0000	13.3117.0000

Kugelglocke, Dome cover

Höhe height		Ø-Außen Ø-outer		18/10 18/10	versilbert silver-plated
mm	in.	mm	in.		
78	3⅛	135	5⅝	12.3105.1350	15.3105.1350

Unterteller, Underliner

Ø-Außen Ø-outer		18/10 18/10	versilbert silver-plated
mm	in.		
159	6¼	12.2024.1600	13.3024.1600



PROFILE

Butterdose, Butter dish
4-tlg., 4-part

Höhe height		Ø-Außen Ø-outer		18/10 18/10	versilbert silver-plated
mm	in.	mm	in.		
93	3⅞	159	6¼	12.3432.0000	15.3432.0000

2-tlg., 2-part

Höhe height		Ø-Außen Ø-outer		18/10 18/10	versilbert silver-plated
mm	in.	mm	in.		
41	1⅝	116	4⅞	12.2117.0000	13.3117.0000

Kugelglocke, Dome cover

Höhe height		Ø-Außen Ø-outer		18/10 18/10	versilbert silver-plated
mm	in.	mm	in.		
81	3⅞	135	5⅝	12.3104.1350	15.3104.1350

Unterteller, Underliner

Ø-Außen Ø-outer		18/10 18/10	versilbert silver-plated
mm	in.		
159	6¼	12.2024.1600	13.3024.1600



EXCLUSIVE

MENÜ & BANKETT · MENU & BANQUET

Butterdose, Butter dish 4-tlg., 4-part

Höhe height		Ø-Außen Ø-outer		18/10 18/10	versilbert silver-plated
mm	in.	mm	in.		
89	3½	159	6¼	12.5232.0000	15.5232.0000

2-tlg., 2-part

Höhe height		Ø-Außen Ø-outer		18/10 18/10	versilbert silver-plated
mm	in.	mm	in.		
41	1⅝	116	4⅞	12.2117.0000	13.3117.0000

Kugelglocke, Dome cover

Höhe height		Ø-Außen Ø-outer		18/10 18/10	versilbert silver-plated
mm	in.	mm	in.		
78	3⅛	135	5⅞	12.3106.1350	15.3106.1350

Unterteller, Underliner

Ø-Außen Ø-outer		18/10 18/10	versilbert silver-plated
mm	in.		
159	6¼	12.2024.1600	13.3024.1600



ARTE

Butterdose, Butter dish 2-tlg., 2-part

Höhe height		Ø-Außen Ø-outer		18/10 18/10	versilbert silver-plated
mm	in.	mm	in.		
79	3⅛	89	3½	12.2218.0000	13.2218.0000

Porzellan-Einsatz, Porcelain insert für Butterdose, for butter dish

Höhe height		Ø-Außen Ø-outer		Porzellan porcelain
mm	in.	mm	in.	
41	1⅝	60	2⅞	50.8868.0000



EXCELLENT

Butterdose, Butter dish
2-tlg., 2-part

Höhe height		Ø-Außen Ø-outer		18/10 18/10	versilbert silver-plated
mm	in.	mm	in.		
76	3	89	3½	12.4918.0000	15.4918.0000

Porzellan-Einsatz, Porcelain insert
für Butterdose, for butter dish

Höhe height		Ø-Außen Ø-outer		Porzellan porcelain
mm	in.	mm	in.	
41	1⅝	60	2⅞	50.8868.0000



PROFILE

Butterdose, Butter dish
2-tlg., 2-part

Höhe height		Ø-Außen Ø-outer		18/10 18/10	versilbert silver-plated
mm	in.	mm	in.		
80	3⅛	89	3½	12.3418.0000	13.3418.0000

Porzellan-Einsatz, Porcelain insert
für Butterdose, for butter dish

Höhe height		Ø-Außen Ø-outer		Porzellan porcelain
mm	in.	mm	in.	
41	1⅝	60	2⅞	50.8868.0000



EXCLUSIVE

MENÜ & BANKETT · MENU & BANQUET

Butterdose, Butter dish 2-tlg., 2-part

Höhe height		Ø-Außen Ø-outer		18/10 18/10	versilbert silver-plated
mm	in.	mm	in.		
76	3	89	3½	12.5318.0000	15.5318.0000

Porzellan-Einsatz, Porcelain insert für Butterdose, for butter dish

Höhe height		Ø-Außen Ø-outer		Porzellan porcelain
mm	in.	mm	in.	
41	1⅝	60	2⅜	50.8868.0000



ARTE

Butterdose, Butter dish 2-tlg., 2-part

Höhe height		Ø-Außen Ø-outer		18/10 18/10	versilbert silver-plated
mm	in.	mm	in.		
41	1⅝	116	4⅞	12.2117.0000	13.3117.0000



Unterteller, Underliner

Ø-Außen Ø-outer		18/10 18/10	versilbert silver-plated
mm	in.		
159	6¼	12.2024.1600	13.3024.1600

NEUTRAL

Butterdose, Butter dish 4-tlg., 4-part

Höhe height		Ø-Außen Ø-outer		18/10 18/10	versilbert silver-plated
mm	in.	mm	in.		
69	2⅞	146	5¾	60.5426.0000	60.7426.0000



EXCELLENT

Butterdose, Butter dish
2-tlg., 2-part

Höhe height		Ø-Außen Ø-outer		18/10 18/10	versilbert silver-plated
mm	in.	mm	in.		
72	2 ¹³ / ₁₆	90	3 ⁹ / ₁₆	60.5480.0000	60.7480.0000



EXCELLENT

Chillcup
komplett für Butter, complete for butter

Höhe height		Ø-Außen Ø-outer		18/10 18/10	versilbert silver-plated
mm	in.	mm	in.		
76	3	127	5	12.2291.0000	15.2291.0000



NEUTRAL

Krümelschaufel, Crumb scraper

Länge length		18/10 18/10	versilbert silver-plated
mm	in.		
230	9 ¹ / ₁₆	12.2154.0000	13.3154.0000



NEUTRAL

Krümelsammler, Table crumbler

Länge length		18/10 18/10
mm	in.	
150	5 ⁷ / ₈	60.5427.0000



NEUTRAL

MENÜ & BANKETT · MENU & BANQUET



Universalständer, Multi purpose stand
für Teller Ø 21 cm, for plate Ø 8³/₄ inch

Breite width		Höhe height		18/10 18/10	versilbert silver-plated
mm	in.	mm	in.		
245	9 ⁵ / ₈	411	16 ³ / ₁₆	12.2078.0000	13.3078.0000

für Teller Ø 24 cm, for plate Ø 9⁷/₁₆ inch

Breite width		Höhe height		18/10 18/10	versilbert silver-plated
mm	in.	mm	in.		
290	11 ⁷ / ₁₆	400	15 ³ / ₄	12.2078.2400	13.3078.2400

NEUTRAL



Universalständer, Multi purpose stand
für Teller Ø 21 cm, for plate Ø 8³/₄ inch

Breite width		Höhe height		18/10 18/10	versilbert silver-plated
mm	in.	mm	in.		
324	12 ³ / ₄	447	17 ⁵ / ₈	12.4178.0000	13.5178.0000

EXCELLENT



Eispräsentationsständer, Ice display stand
für Teller Ø 16 cm, for plate Ø 6⁵/₁₆ inch

Breite width		Höhe height		18/10 18/10	versilbert silver-plated
mm	in.	mm	in.		
184	7 ¹ / ₄	254	10	12.2079.0000	13.3079.0000

NEUTRAL

Sorbetbehälter, Sorbet pot

Inhalt cap.		Höhe height		Ø-Außen Ø-outer		Ø-Innen Ø-inner		18/10
Ltr.	oz.	mm	in.	mm	in.	mm	in.	
1,10	39	205	8 ¹ / ₁₆	165	6 ¹ / ₂	116	4 ⁹ / ₁₆	12.4084.0000



EXCELLENT

Sorbetbehälter, Sorbet pot

Inhalt cap.		Höhe height		Ø-Außen Ø-outer		Ø-Innen Ø-inner		18/10
Ltr.	oz.	mm	in.	mm	in.	mm	in.	
1,10	39	211	8 ⁵ / ₁₆	165	6 ¹ / ₂	116	4 ⁹ / ₁₆	12.3484.0000



EXCLUSIVE

Sorbetbehälter, Sorbet pot

Inhalt cap.		Höhe height		Ø-Außen Ø-outer		Ø-Innen Ø-inner		18/10
Ltr.	oz.	mm	in.	mm	in.	mm	in.	
1,10	39	200	7 ⁷ / ₈	165	6 ¹ / ₂	116	4 ⁹ / ₁₆	12.4884.0000



PROFILE

Sorbetbehälter, Sorbet pot

Inhalt cap.		Höhe height		Ø-Außen Ø-outer		Ø-Innen Ø-inner		18/10
Ltr.	oz.	mm	in.	mm	in.	mm	in.	
1,10	39	200	7 ⁷ / ₈	165	6 ¹ / ₂	116	4 ⁹ / ₁₆	12.5284.0000



ARTE

MENÜ & BANKETT · MENU & BANQUET

Eisschale, Ice cream bowl
auf Fuß, with foot

Inhalt cap.		Höhe height		Ø-Außen Ø-outer		18/10 18/10	versilbert silver-plated
Ltr.	oz.	mm	in.	mm	in.		
0,10	4	67	2 ⁵ / ₈	105	4 ¹ / ₈	10.0731.1000	11.1731.1000



NEUTRAL

Eisschale, Ice cream bowl
auf Fuß, with foot

Inhalt cap.		Höhe height		Ø-Außen Ø-outer		18/10 18/10	versilbert silver-plated
Ltr.	oz.	mm	in.	mm	in.		
0,10	4	45	1 ³ / ₄	105	4 ¹ / ₈	10.0730.1000	11.1730.1000



NEUTRAL

Eisbecher, Ice cream cup

Inhalt cap.		Höhe height		Ø-Außen Ø-outer		18/10 18/10	versilbert silver-plated
Ltr.	oz.	mm	in.	mm	in.		
0,20	7	119	4 ¹¹ / ₁₆	82	3 ¹ / ₄	10.0612.0000	11.1612.0000



NEUTRAL

Brotkorb, Bread basket
rund, round

Höhe height		Ø-Außen Ø-outer		18/10 18/10	versilbert silver-plated
mm	in.	mm	in.		
50	1 ¹⁵ / ₁₆	181	7 ¹ / ₈	12.2137.1800	13.3137.1800
49	1 ¹⁵ / ₁₆	234	9 ³ / ₁₆	12.2137.2300	13.3137.2300



NEUTRAL

Brotkorb, Bread basket
rund, durchbrochen, round, perforated

Höhe height		Ø-Außen Ø-outer		18/10 18/10	versilbert silver-plated
mm	in.	mm	in.		
50	1 ¹⁵ / ₁₆	181	7 ¹ / ₈	12.2719.1800	13.3719.1800
49	1 ¹⁵ / ₁₆	234	9 ³ / ₁₆	12.2719.2300	13.3719.2300



NEUTRAL

Brotkorb, Bread basket
oval

Länge length		Breite width		Höhe height		18/10 18/10	versilbert silver-plated
mm	in.	mm	in.	mm	in.		
234	9 ³ / ₁₆	171	6 ³ / ₄	37	1 ¹ / ₂	12.2136.2300	13.3136.2300
275	10 ¹³ / ₁₆	183	7 ³ / ₁₆	50	1 ¹⁵ / ₁₆	12.2136.2700	13.3136.2700



NEUTRAL

Brotkorb, Bread basket
oval, durchbrochen, oval, perforated

Länge length		Breite width		Höhe height		18/10 18/10	versilbert silver-plated
mm	in.	mm	in.	mm	in.		
234	9 ³ / ₁₆	171	6 ³ / ₄	37	1 ⁷ / ₁₆	12.2720.2300	13.3720.2300



NEUTRAL

Brotkorb, Bread basket
rund, round

Höhe height		Ø-Außen Ø-outer		18/10 18/10	versilbert silver-plated
mm	in.	mm	in.		
52	2 ¹ / ₁₆	188	7 ³ / ₈	12.4937.1800	13.4937.1800



PROFILE

MENÜ & BANKETT · MENU & BANQUET

Brotkorb, Bread basket
oval

Länge length		Breite width		Höhe height		versilbert silver-plated
mm	in.	mm	in.	mm	in.	
270	10 ⁵ / ₈	195	7 ¹¹ / ₁₆	60	2 ³ / ₈	60.7419.2800



NEUTRAL

Brotkorb, Bread basket
oval

Länge length		Breite width		Höhe height		versilbert silver-plated
mm	in.	mm	in.	mm	in.	
188	7 ³ / ₈	135	5 ⁵ / ₁₆	53	2 ¹ / ₁₆	60.9188.2000
226	8 ⁷ / ₈	169	6 ⁷ / ₈	58	2 ⁹ / ₁₆	60.9188.2500



NEUTRAL

Brotkorb, Bread basket
oval

Länge length		Breite width		Höhe height		18/10 18/10	versilbert silver-plated
mm	in.	mm	in.	mm	in.		
308	12 ¹ / ₈	165	6 ¹ / ₂	50	1 ¹⁵ / ₁₆	60.5483.3080	60.7483.3080



NEUTRAL

Austerngestell, Oyster rack

Höhe height		Ø-Außen Ø-outer		18/10 18/10	versilbert silver-plated
mm	in.	mm	in.		
208	8 ³ / ₁₆	360	14 ³ / ₁₆	12.2132.3600	13.3132.3600

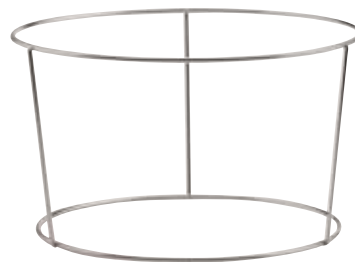

NEUTRAL

Servierblech, Serving tray rund, round

Ø-Außen Ø-outer		18/10 18/10	versilbert silver-plated
mm	in.		
369	14 ¹ / ₂	12.2037.3600	13.3037.3600



NEUTRAL

Fingerschale, Finger bowl

Inhalt cap.		Höhe height		Ø-Außen Ø-outer		18/10 18/10	versilbert silver-plated
Ltr.	oz.	mm	in.	mm	in.		
0,25	9	49	1 ¹⁵ / ₁₆	105	4 ¹ / ₈	60.5447.0000	60.7447.0000



NEUTRAL

Unterteller, Underliner

Ø-Außen Ø-outer		18/10 18/10	versilbert silver-plated
mm	in.		
159	6 ³ / ₄	12.2024.1600	13.3024.1600



NEUTRAL

EDEL FOOD · EXCLUSIVE FOOD



Chillcup
komplett für Scampis, complete for scampis

Inhalt cap.		Höhe height		Ø-Außen Ø-outer		18/10	versilbert silver-plated
Ltr.	oz.	mm	in.	mm	in.	18/10	
0,15	5	113	4 ⁷ / ₁₆	129	5 ¹ / ₁₆	12.2294.0000	15.2294.0000

NEUTRAL



Chillcup

Inhalt cap.		Höhe height		Ø-Außen Ø-outer		18/10	versilbert silver-plated
Ltr.	oz.	mm	in.	mm	in.	18/10	
0,30	11	75	2 ¹⁵ / ₁₆	125	4 ¹⁵ / ₁₆	10.0620.0000	11.1620.0000

NEUTRAL



Chillcup
komplett für Kaviar, complete for caviar

Inhalt cap.		Höhe height		Ø-Außen Ø-outer		18/10	versilbert silver-plated
Ltr.	oz.	mm	in.	mm	in.	18/10	
0,03	1	79	3 ¹ / ₈	127	5	12.2292.0000	15.2292.0000

NEUTRAL



Chillcup
3-tlg., 3-part

Inhalt cap.		Höhe height		Ø-Außen Ø-outer		18/10	versilbert silver-plated
Ltr.	oz.	mm	in.	mm	in.	18/10	
0,10	4	93	3 ¹¹ / ₁₆	129	5 ¹ / ₁₆	10.0619.0000	11.1619.0000

NEUTRAL

Glaseinsatz, Glass insert
für Chillcup, for chillcup

Inhalt cap.		Höhe height		Ø-Außen Ø-outer		Glas glass
Ltr.	oz.	mm	in.	mm	in.	
0,15	5	51	2	110	4 ⁵ / ₁₆	50.8345.0000



NEUTRAL

Schneckenpfanne, Snail dish
für 6 Stück, for 6 pieces

Ø-Außen Ø-outer			
mm	in.		
150	5 ⁷ / ₈	18/10 18/10	versilbert silver-plated
		60.8833.1300	60.9033.1300



NEUTRAL

Schneckenpfanne, Snail dish
für 12 Stück, for 12 pieces

Ø-Außen Ø-outer			
mm	in.		
185	7 ⁵ / ₁₆	18/10 18/10	versilbert silver-plated
		60.8833.1800	60.9033.1800



NEUTRAL

WÜRZEN · SEASONINGS



Essig-Ölgestell, Vinegar and oil stand

Höhe height		18/10 18/10	versilbert silver-plated
mm	in.		
210	8 ¹ / ₄	12.4141.0000	15.5141.0000

EXCELLENT



Essig-Ölgestell, Vinegar and oil stand

Höhe height		18/10 18/10	versilbert silver-plated
mm	in.		
203	8	12.4841.0000	15.4841.0000

PROFILE



Essig-Ölgestell, Vinegar and oil stand

Höhe height		18/10 18/10	versilbert silver-plated
mm	in.		
213	8 ³ / ₈	12.3441.0000	15.3441.0000

EXCLUSIVE



Essig-Ölgestell, Vinegar and oil stand

Höhe height		18/10 18/10	versilbert silver-plated
mm	in.		
203	8	12.5241.0000	15.5241.0000

ARTE

Menage, Cruet stand
4-tlg., 4-part

Höhe height		18/10 18/10	versilbert silver-plated
mm	in.		
205	8 ¹ / ₁₆	12.2227.0000	15.2227.0000



EXCELLENT

Essig-Ölglas, Glas for vinegar and oil
mit Gestell, with holder

Höhe height			vernickelt nickel-plated
mm	in.		
188	7 ³ / ₈		60.5409.0000



NEUTRAL

Pfeffermühle, Pepper mill

Höhe height			Holz wood
mm	in.		
300	11 ¹³ / ₁₆		60.6260.0000



NEUTRAL

Pfeffermühle, Pepper mill

Höhe height			Holz wood
mm	in.		
369	14 ¹ / ₂		60.5412.0000



NEUTRAL

WÜRZEN · SEASONINGS



Salzmühle, Salt mill

Höhe height		Holz wood
mm	in.	
145	5 ¹¹ / ₁₆	60.5408.0000

Pfeffermühle, Pepper mill

Höhe height		Holz wood
mm	in.	
145	5 ¹¹ / ₁₆	60.5410.0000

NEUTRAL



Salz- und Pfeffermühle, Salt- and Pepper mill

Höhe height		Acrylglas acryl
mm	in.	
104	4 ¹ / ₈	60.8896.0000

NEUTRAL



Salzmühle, Salt mill

Höhe height		18/10	versilbert silver-plated
mm	in.		
100	3 ¹⁵ / ₁₆	12.4867.0000	15.4867.0000

Pfeffermühle, Pepper mill

Höhe height		18/10	versilbert silver-plated
mm	in.		
100	3 ¹⁵ / ₁₆	12.4865.0000	15.4865.0000

PROFILE



Salzmühle, Salt mill

Höhe height		18/10	versilbert silver-plated
mm	in.		
100	3 ¹⁵ / ₁₆	12.5267.0000	15.5267.0000

Pfeffermühle, Pepper mill

Höhe height		18/10	versilbert silver-plated
mm	in.		
100	3 ¹⁵ / ₁₆	12.5265.0000	15.5265.0000

ARTE

Salzstreuer, Salt shaker

Höhe height		18/10	versilbert silver-plated
mm	in.		
70	2 ³ / ₄	60.5655.0700	60.7655.0700
90	3 ⁹ / ₁₆	60.5655.0900	60.7655.0900

Pfefferstreuer, Pepper shaker

Höhe height		18/10	versilbert silver-plated
mm	in.		
70	2 ³ / ₄	60.5656.0700	60.7656.0700
90	3 ⁹ / ₁₆	60.5656.0900	60.7656.0900



NEUTRAL

Salzstreuer, Salt shaker

Höhe height		18/10	versilbert silver-plated
mm	in.		
71	2 ¹³ / ₁₆	60.5486.0000	60.7486.0000

Pfefferstreuer, Pepper shaker

Höhe height		18/10	versilbert silver-plated
mm	in.		
71	2 ¹³ / ₁₆	60.5487.0000	60.7487.0000



NEUTRAL

Salzstreuer, Salt shaker

Höhe height		18/10	versilbert silver-plated
mm	in.		
76	3	60.5455.0000	60.7455.0000

Pfefferstreuer, Pepper shaker

Höhe height		18/10	versilbert silver-plated
mm	in.		
76	3	60.5456.0000	60.7456.0000



NEUTRAL

**Menage, Cruet stand
2-tlg., 2-part**

Höhe height		18/10	versilbert silver-plated
mm	in.		
142	5 ⁹ / ₁₆	12.4130.0000	15.5130.0000



EXCELLENT

WÜRZEN · SEASONINGS



Menage, Cruet stand
2-tlg., 2-part

Höhe height		18/10 18/10	versilbert silver-plated
mm	in.		
134	5 ¹ / ₄	12.4830.0000	15.4830.0000

PROFILE



Menage, Cruet stand
2-tlg., 2-part

Höhe height		18/10 18/10	versilbert silver-plated
mm	in.		
148	5 ¹³ / ₁₆	12.3430.0000	15.3430.0000

EXCLUSIVE



Senfgefäß, Mustard pot

Höhe height		18/10 18/10	versilbert silver-plated
mm	in.		
102	4	12.2282.0000	15.2282.0000

EXCELLENT



Senfgefäß, Mustard pot

Höhe height		18/10 18/10	versilbert silver-plated
mm	in.		
100	3 ¹⁵ / ₁₆	12.4882.0000	15.4882.0000

PROFILE

Senfgefäß, Mustard pot

Höhe height		18/10 18/10	versilbert silver-plated
mm	in.		
104	4 ¹ / ₈	12.3482.0000	15.3482.0000



EXCLUSIVE

Senfgefäß, Mustard pot

Höhe height		18/10 18/10	versilbert silver-plated
mm	in.		
100	3 ¹⁵ / ₁₆	12.5282.0000	15.5282.0000



ARTE

Käsedose, Cheese dish

Höhe height		18/10 18/10	versilbert silver-plated
mm	in.		
81	3 ³ / ₁₆	12.2280.0000	15.2280.0000



EXCELLENT

Käsedose, Cheese dish

Höhe height		18/10 18/10	versilbert silver-plated
mm	in.		
79	3 ¹ / ₈	12.4880.0000	15.4880.0000



PROFILE

WÜRZEN · SEASONINGS

Käsedose, Cheese dish

Höhe height		18/10	versilbert silver-plated
mm	in.	18/10	
83	3 ¹ / ₄	12.3480.0000	15.3480.0000



EXCLUSIVE

Käsedose, Cheese dish

Höhe height		18/10	versilbert silver-plated
mm	in.	18/10	
79	3 ¹ / ₈	12.5280.0000	15.5280.0000



ARTE

Zahnstocherbehälter, Toothpick stand

Höhe height		18/10	versilbert silver-plated
mm	in.	18/10	
80	3 ¹ / ₈	12.2231.0000	13.2231.0000



NEUTRAL

Leuchter, Candelabra
ohne Kerzen, without candles

Höhe ohne Kerzen
height without candles

Höhe height		18/10	versilbert silver-plated
mm	in.		
220	8 ¹¹ / ₁₆	60.5508.0030	60.7508.0030



EXCELLENT

Leuchter, Candelabra
ohne Kerzen, without candles

Höhe ohne Kerzen
height without candles

Höhe height		18/10	versilbert silver-plated
mm	in.		
286	11 ¹ / ₄	12.4843.0030	13.4843.0030



PROFILE

Leuchter, Candelabra
ohne Kerzen, without candles

Höhe ohne Kerzen
height without candles

Höhe height		18/10	versilbert silver-plated
mm	in.		
286	11 ¹ / ₄	12.5343.0030	13.5343.0030



ARTE

TISCH-ACCESSOIRES · TABLE ACCESSOIRES



Leuchter, Candelabra
ohne Kerzen, without candles
Höhe ohne Kerzen
height without candles

Höhe height		18/10 18/10	versilbert silver-plated
mm	in.		
220	8 ¹¹ / ₁₆	60.5509.0050	60.7509.0050

EXCELLENT



Leuchter, Candelabra
ohne Kerzen, without candles
Höhe ohne Kerzen
height without candles

Höhe height		18/10 18/10	versilbert silver-plated
mm	in.		
303	11 ¹⁵ / ₁₆	12.4843.0050	13.4843.0050

PROFILE



Leuchter, Candelabra
ohne Kerzen, without candles
Höhe ohne Kerzen
height without candles

Höhe height		18/10 18/10	versilbert silver-plated
mm	in.		
303	11 ¹⁵ / ₁₆	12.5343.0050	13.5343.0050

ARTE

Bankett-Leuchter, Candelabra for banquet
ohne Kerzen, without candles

Höhe ohne Kerzen
height without candles

Höhe height		18/10 18/10	versilbert silver-plated
mm	in.		
535	21 ¹ / ₁₆	12.4845.5400	13.4845.5400



PROFILE

Leuchter, Candelabra
ohne Kerze, without candle

Höhe ohne Kerzen
height without candles

Höhe height		18/10 18/10	versilbert silver-plated
mm	in.		
110	4 ⁵ / ₁₆	60.5507.1110	60.7507.1110
180	7 ¹ / ₁₆	60.5507.1810	60.7507.1810



EXCELLENT

Leuchter, Candelabra
ohne Kerze, without candle

Höhe ohne Kerzen
height without candles

Höhe height		18/10 18/10	versilbert silver-plated
mm	in.		
180	7 ¹ / ₁₆	12.2245.1800	15.2245.1800



EXCELLENT

TISCH-ACCESSOIRES · TABLE ACCESSOIRES



Leuchter, Candelabra
ohne Kerze, without candle
Höhe ohne Kerzen
height without candles

Höhe height		18/10 18/10	versilbert silver-plated
mm	in.		
180	7 ¹ / ₁₆	12.4843.1800	13.4843.1800

PROFILE



Tülle für Leuchter, Cup for candleholder
für Leuchter „Profile“ und „Arte“
for candle holder „Profile“ and „Arte“

Höhe height		Ø-Außen Ø-outer		18/10 18/10	versilbert silver-plated
mm	in.	mm	in.		
80	3 ² / ₁₆	80	3 ² / ₁₆	12.4843.0000	13.4843.0000

NEUTRAL



Windlicht, Candle lamp

Höhe height		18/10 18/10	versilbert silver-plated
mm	in.		
218	8 ⁹ / ₁₆	60.5511.0000	60.7511.0000

EXCELLENT



Blumenvase, Vase

Höhe height		18/10 18/10	versilbert silver-plated
mm	in.		
180	7 ¹ / ₁₆	60.5510.1800	60.7510.1800

EXCELLENT

Blumenvase, Vase

Höhe height		18/10 18/10	versilbert silver-plated
mm	in.		
180	7 ¹ / ₁₆	12.2246.1800	15.2246.1800



EXCELLENT

Blumenvase, Vase

Höhe height		18/10 18/10	versilbert silver-plated
mm	in.		
180	7 ¹ / ₁₆	12.4844.1800	13.4844.1800



PROFILE

Blumenvase, Vase

Höhe height		18/10 18/10	versilbert silver-plated
mm	in.		
180	7 ¹ / ₁₆	12.5344.1800	13.5344.1800



ARTE

Tischnummernständer, Table number stand

Höhe height		18/10 18/10	versilbert silver-plated
mm	in.		
190	7 ¹ / ₂	60.5495.1900	60.7495.1900
460	18 ¹ / ₈	60.5495.4600	60.7495.4600



NEUTRAL

TISCH-ACCESSOIRES · TABLE ACCESSOIRES

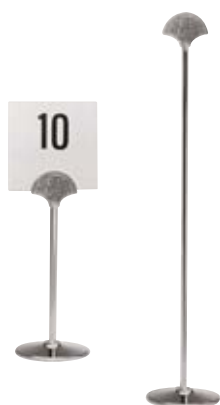

Tischnummernständer, Table number stand

Höhe height		18/10 18/10		versilbert silver-plated	
mm	in.				
220	8 ¹¹ / ₁₆	12.2263.2200		15.2263.2200	
500	19 ¹¹ / ₁₆	12.2263.5000		15.2263.5000	

NEUTRAL



Tischnummer, Table number

Länge length		Breite width		Kunststoff plastics	
mm	in.	mm	in.		
115	4 ¹ / ₂	110	4 ⁵ / ₁₆		41.8050.0000
Länge length		Breite width		18/10 18/10	
mm	in.	mm	in.		versilbert silver-plated
60	2 ³ / ₈	60	2 ³ / ₈	12.2076.0600	13.3076.0600
115	4 ¹ / ₂	110	4 ⁵ / ₁₆	12.2076.1000	13.3076.1000

NEUTRAL



Tischnummernständer, Table number stand

Höhe height		18/10 18/10		versilbert silver-plated	
mm	in.				
200	7 ⁷ / ₈	12.2264.2000		13.2264.2000	

NEUTRAL



Reservierschild, Reserved sign

Länge length		Breite width		18/10 18/10	
mm	in.	mm	in.		versilbert silver-plated
82	3 ¹ / ₄	36	1 ⁷ / ₁₆	12.2453.0000	13.2453.0000

NEUTRAL

Nichtraucherschild, No Smoking sign

Länge length		Breite width		18/10 18/10	versilbert silver-plated
mm	in.	mm	in.		
60	2 ³ / ₈	56	2 ³ / ₁₆	12.2260.0000	13.2260.0000



NEUTRAL

Tischnummernschild, Table number sign

Länge length		Breite width		18/10 18/10	versilbert silver-plated
mm	in.	mm	in.		
85	3 ³ / ₈	39	1 ⁹ / ₁₆	12.2452.0000	13.2452.0000



NEUTRAL

Tischnummernschild, Table number sign

Länge length		Breite width		18/10 18/10	versilbert silver-plated
mm	in.	mm	in.		
60	2 ³ / ₈	60	2 ³ / ₈	12.2451.0000	13.2451.0000



NEUTRAL



Ein visueller Aperitif

Exklusive Tischkultur für Feinschmecker. Egal ob bei Banketts oder bei Veranstaltungen, unsere bewährten Modelle und Sonderanfertigungen bestechen durch Ihre Vielfalt und erfüllen jeden noch so hohen Anspruch in bekannter HEPP-Qualität. Das Highlight jedes Banketts ist der spannende Augenblick des Servierens. Präsentiert in edlen Gefäßen avancieren die kulinarischen Köstlichkeiten zu wahren Kunstwerken und werden zum unvergesslichen Erlebnis für jeden Gast. Das ist exklusive Servierkultur für Feinschmecker.



A visual aperitif

Exclusive serving culture for connoisseurs. No matter whether we are talking about banquets or functions, our models and special products have the quality you've become accustomed to. HEPP's diversity suits every taste, no matter how demanding. The highlight of any banquet is the thrill of serving. Presented in exquisite dishes, the culinary specialties develop into real works of art, making it an unforgettable experience for each and every guest. That is the exclusive serving culture for gourmets.



CHAFING DISH & BUFFET



CHAFING DISH & BUFFET

Chafing Dish GN 1/1
mit ganz rollender Haube, with full roll top cover
für Brennstoff oder Elektroheizung, ohne Einsätze, ohne Elektroheizung
for burner or electrical heating, without inserts, without electrical heating

Elektroheizung 60.8880.0020, Seite 144
Heating element 60.8880.0020, page 144



Länge length		Breite width		Höhe height		18/10	versilbert silver-plated
mm	in.	mm	in.	mm	in.		
690	27 ⁹ / ₁₆	385	15 ³ / ₁₆	460	18 ¹ / ₈	12.3494.0320	15.3494.0320

EXCLUSIVE

Chafing Dish Ø 30 cm
rund mit ganz rollender Haube, round with full roll top cover
für Brennstoff oder Elektroheizung, mit Einsätze, ohne Elektroheizung
for burner or electrical heating, with inserts, without electrical heating

Elektroheizung 60.8880.0030, Seite 143
Heating element 60.8880.0030, page 143



Breite width		Höhe height		18/10	versilbert silver-plated
mm	in.	mm	in.	18/10	
450	17 ¹¹ / ₁₆	490	19 ⁵ / ₁₆	12.3493.1320	15.3493.1320

EXCLUSIVE

Chafing Dish Ø 40 cm
rund mit ganz rollender Haube, round with full roll top cover
für Brennstoff oder Elektroheizung, mit Einsätze, ohne Elektroheizung
for burner or electrical heating, with inserts, without electrical heating

Elektroheizung 60.8880.0020, Seite 144
Heating element 60.8880.0020, page 144



Breite width		Höhe height		18/10	versilbert silver-plated
mm	in.	mm	in.	18/10	
545	21 ⁷ / ₁₆	600	23 ⁵ / ₈	12.3493.2320	15.3493.2320

EXCLUSIVE

Chafing Dish

rund mit ganz rollender Haube, round with full roll top cover

für Brennstoff, mit Einsätze
for burner, with inserts

Breite width		Höhe height		Ø	18/10	versilbert silver-plated
mm	in.	mm	in.	mm		
237	9 ⁵ / ₁₆	305	12	21	12.3493.4010	15.3493.4010
325	12 ¹³ / ₁₆	350	13 ³ / ₄	24	12.3493.3010	15.3493.3010



EXCLUSIVE

Chafing Dish GN 1/1

mit ganz rollender Haube, stapelbar, with full roll top cover, stackable

für Brennstoff oder Elektroheizung, ohne Einsätze, ohne Elektroheizung
for burner or electrical heating, without inserts, without electrical heating

Elektroheizung 60.8880.0020, Seite 144
Heating element 60.8880.0020, page 144

Länge length		Breite width		Höhe height		18/10	versilbert silver-plated
mm	in.	mm	in.	mm	in.		
700	27 ⁹ / ₁₆	400	15 ³ / ₄	470	18 ¹ / ₂	12.4094.0320	13.4594.0320



EXCELLENT

Chafing Dish Ø 30 cm

mit ganz rollender Haube, stapelbar, with full roll top cover, stackable

für Brennstoff oder Elektroheizung, mit Einsätze, ohne Elektroheizung
for burner or electrical heating, with inserts, without electrical heating

Elektroheizung 60.8880.0030, Seite 143
Heating element 60.8880.0030, page 143

Breite width		Höhe height		18/10	versilbert silver-plated
mm	in.	mm	in.		
450	17 ¹¹ / ₁₆	480	18 ⁷ / ₈	12.4093.1320	13.4593.1320



EXCELLENT

CHAFING DISH & BUFFET



Chafing Dish Ø 40 cm
mit ganz rollender Haube, stapelbar, with full roll top cover, stackable
für Brennstoff oder Elektroheizung, mit Einsätze, ohne Elektroheizung
for burner or electrical heating, with inserts, without electrical heating

Elektroheizung 60.8880.0020, Seite 144
Heating element 60.8880.0020, page 144

Breite width		Höhe height		18/10 18/10	versilbert silver-plated
mm	in.	mm	in.		
555	21 ⁷ / ₈	600	23 ⁵ / ₈	12.4093.2320	13.4593.2320

EXCELLENT



Chafing Dish GN 1/1
mit ganz rollender Haube, with full roll top cover
für Brennstoff oder Elektroheizung, ohne Einsätze, ohne Elektroheizung
for burner or electrical heating, without inserts, without electrical heating

Elektroheizung 60.8880.0020, Seite 144
Heating element 60.8880.0020, page 144

Länge length		Breite width		Höhe height		18/10 18/10	versilbert silver-plated
mm	in.	mm	in.	mm	in.		
710	27 ¹⁵ / ₁₆	390	15 ³ / ₈	445	17 ¹ / ₂	12.4895.0320	13.4895.0320

PROFILE



Chafing Dish Ø 30 cm
mit ganz rollender Haube, with full roll top cover
für Brennstoff oder Elektroheizung, mit Einsätze, ohne Elektroheizung
for burner or electrical heating, with inserts, without electrical heating

Elektroheizung 60.8880.0030, Seite 143
Heating element 60.8880.0030, page 143

Länge length		Breite width		Höhe height		18/10 18/10	versilbert silver-plated
mm	in.	mm	in.	mm	in.		
410	16 ¹ / ₈	450	17 ¹¹ / ₁₆	475	18 ¹¹ / ₁₆	12.4896.1320	13.4896.1320

PROFILE

Chafing Dish Ø 40 cm

mit ganz rollender Haube, with full roll top cover

für Brennstoff oder Elektroheizung, mit Einsätze, ohne Elektroheizung
for burner or electrical heating, with inserts, without electrical heating

Elektroheizung 60.8880.0020, Seite 144
Heating element 60.8880.0020, page 144

Länge length		Breite width		Höhe height		18/10	versilbert silver-plated
mm	in.	mm	in.	mm	in.	18/10	
500	19 ¹¹ / ₁₆	540	21 ¹ / ₄	580	22 ¹³ / ₁₆	12.4896.2320	13.4896.2320



PROFILE

Chafing Dish GN 1/1

mit ganz rollender Haube, with full roll top cover

für Brennstoff oder Elektroheizung, ohne Einsätze, ohne Elektroheizung
for burner or electrical heating, without inserts, without electrical heating

Elektroheizung 60.8880.0020, Seite 144
Heating element 60.8880.0020, page 144

Länge length		Breite width		Höhe height		18/10	versilbert silver-plated
mm	in.	mm	in.	mm	in.	18/10	
710	27 ¹⁵ / ₁₆	390	15 ³ / ₈	445	17 ¹ / ₂	12.5294.0320	13.5294.0320



ARTE

Chafing Dish Ø 30 cm

mit ganz rollender Haube, with full roll top cover

für Brennstoff oder Elektroheizung, mit Einsätze, ohne Elektroheizung
for burner or electrical heating, with inserts, without electrical heating

Elektroheizung 60.8880.0030, Seite 143
Heating element 60.8880.0030, page 143

Länge length		Breite width		Höhe height		18/10	versilbert silver-plated
mm	in.	mm	in.	mm	in.	18/10	
410	16 ¹ / ₈	450	17 ¹¹ / ₁₆	475	18 ¹¹ / ₁₆	12.5293.1320	13.5293.1320



ARTE

CHAFING DISH & BUFFET

Chafing Dish Ø 40 cm

mit ganz rollender Haube, with full roll top cover

für Brennstoff oder Elektroheizung, mit Einsätze, ohne Elektroheizung
for burner or electrical heating, with inserts, without electrical heating

Elektroheizung 60.8880.0020, Seite 144

Heating element 60.8880.0020, page 144

Länge length		Breite width		Höhe height		18/10 18/10	versilbert silver-plated
mm	in.	mm	in.	mm	in.		
500	19 ¹¹ / ₁₆	540	21 ¹ / ₄	580	22 ¹³ / ₁₆	12.5293.2320	13.5293.2320



ARTE

Chafing Dish GN 1/1

Thekeneinbau, to be built into counter

für Elektroheizung, ohne Einsätze, ohne Elektroheizung
for electrical heating, without inserts, without electrical heating

Elektroheizung 60.8880.0020, Seite 144

Heating element 60.8880.0020, page 144

Außenschnittmaß outer cut dimension		Tiefe depth		18/10 18/10	versilbert silver-plated
mm	in.	mm	in.		
625 x 408	24 ⁵ / ₈ x 16 ¹ / ₁₆	300	11 ¹³ / ₁₆	12.2089.0320	13.3089.0320



Ausschnittmaß Draufsicht
Cut-out dimension, top view
Côte de coupe, vue de dessus

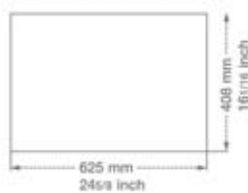

Ausschnittmaß Seitenansicht
Cut-out dimension, side view
Côte de coupe, vue de côté



NEUTRAL

Chafing Dish Ø 30 cm

Thekeneinbau rund, to be built into counter round

für Elektroheizung, mit Einsätze, ohne Elektroheizung
for electrical heating, with inserts, without electrical heating

Elektroheizung 60.8880.0030, Seite 143
Heating element 60.8880.0030, page 143

Außenschnittmaß outer cut dimension		Tiefe depth		18/10	versilbert silver-plated
mm	in.	mm	in.		
395	15 ⁹ / ₁₆	250	9 ¹³ / ₁₆	12.2090.1220	13.3090.1220

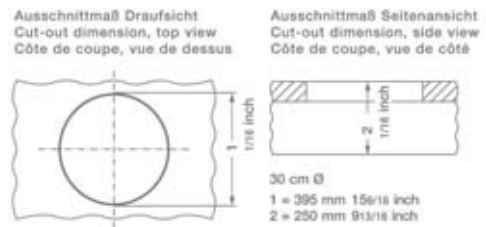

NEUTRAL

Chafing Dish Ø 40 cm

Thekeneinbau rund, to be built into counter round

für Elektroheizung, mit Einsätze, ohne Elektroheizung
for electrical heating, with inserts, without electrical heating

Elektroheizung 60.8880.0020, Seite 144
Heating element 60.8880.0020, page 144

Außenschnittmaß outer cut dimension		Tiefe depth		18/10	versilbert silver-plated
mm	in.	mm	in.		
495	19 ¹ / ₄	300	11 ¹³ / ₁₆	12.2090.2220	13.3090.2220

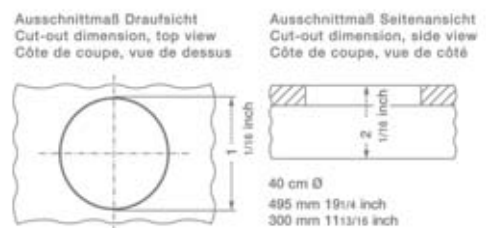

NEUTRAL

CHAFING DISH & BUFFET



Chafing Dish GN 1/1
mit abnehmbarer Haube, with removable cover

für Brennstoff oder Elektroheizung, mit Gastronorm-Einsatz, ohne Elektroheizung
for burner or electrical heating, with gastronorm-insert, without electrical heating

Elektroheizung 60.8883.0040, Seite 144
Heating element 60.8883.0040, page 144

Länge length		Breite width		Höhe height		18/10 18/10	versilbert silver-plated
mm	in.	mm	in.	mm	in.		
640	25 ³ / ₁₆	348	13 ¹¹ / ₁₆	321	12 ⁵ / ₈	60.5423.0000	60.8423.0000

NEUTRAL



Chafing Dish GN 1/1
mit halbrollender Haube, with half roll top cover

für Brennstoff oder Elektroheizung, ohne Einsätze, ohne Elektroheizung
for burner or electrical heating, without inserts, without electrical heating

Elektroheizung 60.8883.0040, Seite 144
Heating element 60.8883.0040, page 144

Länge length		Breite width		Höhe height		18/10 18/10	versilbert silver-plated
mm	in.	mm	in.	mm	in.		
640	25 ³ / ₁₆	360	14 ³ / ₁₆	430	16 ¹⁵ / ₁₆	60.5324.0000	60.7324.0000

NEUTRAL



Suppenstation, Soup station
komplett, complete

für Brennstoff oder Elektroheizung, ohne Elektroheizung
for burner or electrical heating, without electrical heating

Elektroheizung 60.8883.0040, Seite 144
Heating element 60.8883.0040, page 144

Inhalt cap.		Länge length		Breite width		Höhe height		18/10 18/10	versilbert silver-plated
Ltr.	oz.	mm	in.	mm	in.	mm	in.		
2x4,50	2x158	640	25 ³ / ₁₆	345	13 ⁹ / ₁₆	380	14 ¹⁵ / ₁₆	60.5595.0000	60.7595.0000

NEUTRAL

Suppenmarmite, Soup marmite

für Brennstoff oder Elektroheizung, ohne Elektroheizung
for burner or electrical heating, without electrical heating

Elektroheizung 60.8880.0030, Seite 143
Heating element 60.8880.0030, page 143

Inhalt cap.		Höhe height		Ø-Außen Ø-outer		18/10	18/10	versilbert silver-plated
Ltr.	oz.	mm	in.	mm	in.			
4,50	158	390	15 ³ / ₈	235	9 ¹ / ₄	12.5599.1120	13.5599.1120	
9,00	317	410	16 ¹ / ₈	320	12 ⁵ / ₈	12.5599.2120	13.5599.2120	



NEUTRAL

Suppenstation, Soup station

für Chafing Dish Ø 30 cm, rund, for Chafing Dish Ø 30 cm, round

Inhalt cap.		Ø-Außen Ø-outer		18/10	18/10	versilbert silver-plated
Ltr.	oz.	mm	in.			
4,50	158	345	13 ⁹ / ₁₆	12.2073.0000	13.3073.0000	
9,00	317	345	13 ⁹ / ₁₆	60.8873.0000	60.9073.0000	



NEUTRAL

Suppenstation, Soup station

für Chafing Dish GN 1/1, for Chafing Dish GN 1/1

Inhalt cap.		Länge length		Breite width		18/10	18/10	versilbert silver-plated
Ltr.	oz.	mm	in.	mm	in.			
2 x 4,50	2 x 158	530	20 ⁷ / ₈	325	12 ¹³ / ₁₆	60.8872.0000	60.9072.0000	



NEUTRAL

CHAFING DISH & BUFFET



Chafing Dish
rund für Sauce, round for sauce

Inhalt cap.		Höhe height		Ø-Außen Ø-outer		18/10 18/10	versilbert silver-plated
Ltr.	oz.	mm	in.	mm	in.		
1,00	35	255	10 ¹ / ₁₆	171	6 ³ / ₄	12.2297.0000	15.2297.0000

NEUTRAL

Chafing Dish Haube GN 1/1, Chafing Dish cover GN 1/1
halbrollend, half-rolling

Länge length		Breite width		Höhe height		18/10 18/10	versilbert silver-plated
mm	in.	mm	in.	mm	in.		
538	21 ³ / ₁₆	338	9 ³ / ₈	214	8 ⁷ / ₁₆	60.5425.0000	60.7425.0000



NEUTRAL

Hygieneschutz-Haube, Sneeze guard

Länge length		Breite width		Höhe height		18/10 18/10
mm	in.	mm	in.	mm	in.	
750	29 ¹ / ₂	470	18 ¹ / ₂	700	27 ⁹ / ₁₆	12.2159.0000



NEUTRAL

Einsatz für Chafing Dish, Insert for Chafing Dish
Gastronorm 1/1

Inhalt cap.		Länge length		Breite width		Höhe height		18/10 18/10
Ltr.	oz.	mm	in.	mm	in.	mm	in.	
9,50	335	530	20 ⁷ / ₈	325	12 ¹³ / ₁₆	65	2 ⁹ / ₁₆	60.8824.0110
14,00	493	530	20 ⁷ / ₈	325	12 ¹³ / ₁₆	100	3 ¹⁵ / ₁₆	60.8825.0110



NEUTRAL

Einsatz für Chafing Dish, Insert for Chafing Dish
Gastronorm 1/2

Inhalt cap.		Länge length		Breite width		Höhe height		18/10
Ltr.	oz.	mm	in.	mm	in.	mm	in.	18/10
3,75	132	265	10 ⁷ / ₁₆	325	12 ¹³ / ₁₆	65	2 ⁹ / ₁₆	60.8824.0120
6,50	229	265	10 ⁷ / ₁₆	325	12 ¹³ / ₁₆	100	3 ¹⁵ / ₁₆	60.8825.0120



NEUTRAL

Einsatz für Chafing Dish, Insert for Chafing Dish
Gastronorm 2/3

Inhalt cap.		Länge length		Breite width		Höhe height		18/10
Ltr.	oz.	mm	in.	mm	in.	mm	in.	18/10
5,50	194	354	13 ¹⁵ / ₁₆	325	12 ¹³ / ₁₆	65	2 ⁹ / ₁₆	60.8824.0230
9,00	317	354	13 ¹⁵ / ₁₆	325	12 ¹³ / ₁₆	100	3 ¹⁵ / ₁₆	60.8825.0230



NEUTRAL

Einsatz für Chafing Dish, Insert for Chafing Dish
Gastronorm 1/3

Inhalt cap.		Länge length		Breite width		Höhe height		18/10
Ltr.	oz.	mm	in.	mm	in.	mm	in.	18/10
2,50	88	176	6 ¹⁵ / ₁₆	325	12 ¹³ / ₁₆	65	2 ⁹ / ₁₆	60.8824.0130
3,75	132	176	6 ¹⁵ / ₁₆	325	12 ¹³ / ₁₆	100	3 ¹⁵ / ₁₆	60.8825.0130



NEUTRAL

Porzellan-Einsatz, Porcelain insert
Gastronorm 1/1

Inhalt cap.		Länge length		Breite width		Höhe height		Porzellan porcelain
Ltr.	oz.	mm	in.	mm	in.	mm	in.	Porzellan porcelain
8,00	282	530	20 ⁷ / ₈	325	12 ¹³ / ₁₆	65	2 ⁹ / ₁₆	50.8366.0110



NEUTRAL

CHAFING DISH & BUFFET

Porzellan-Einsatz, Porcelain insert Gastronorm 1/2

Inhalt cap.		Länge length		Breite width		Höhe height		Porzellan porcelain
Ltr.	oz.	mm	in.	mm	in.	mm	in.	
3,30	116	265	10 ⁷ / ₁₆	325	12 ¹³ / ₁₆	65	2 ⁹ / ₁₆	50.8366.0120



NEUTRAL

Porzellan-Einsatz, Porcelain insert Gastronorm 2/3

Inhalt cap.		Länge length		Breite width		Höhe height		Porzellan porcelain
Ltr.	oz.	mm	in.	mm	in.	mm	in.	
5,50	194	354	13 ¹⁵ / ₁₆	325	12 ¹³ / ₁₆	65	2 ⁹ / ₁₆	50.8366.0230



NEUTRAL

Porzellan-Einsatz, Porcelain insert Gastronorm 1/3

Inhalt cap.		Länge length		Breite width		Höhe height		Porzellan porcelain
Ltr.	oz.	mm	in.	mm	in.	mm	in.	
2,30	81	175	6 ⁷ / ₈	325	12 ¹³ / ₁₆	65	2 ⁹ / ₁₆	50.8366.0130



NEUTRAL

Porzellan-Einsatz, Porcelain insert für Chafing Dish, for Chafing Dish

Inhalt cap.		Höhe height		Ø	Ø-Außen Ø-outer	Porzellan porcelain	
Ltr.	oz.	mm	in.	mm	mm	in.	
1,00	35	56	2 ³ / ₁₆	Ø 24 cm	261	10 ¹ / ₄	60.8874.2400
3,00	106	69	2 ¹¹ / ₁₆	Ø 30 cm	335	13 ³ / ₁₆	60.8874.3000
5,00	176	80	3 ¹ / ₈	Ø 40 cm	418	16 ⁷ / ₁₆	60.8874.4000



NEUTRAL

Porzellan-Einsatz, Porcelain insert
für Chafing Dish, 2-tlg., for Chafing Dish, 2-part

Inhalt cap.		Höhe height		Ø	Ø-Außen Ø-outer		Porzellan porcelain
Ltr.	oz.	mm	in.	mm	mm	in.	
2,60	92	65	2 ⁹ / ₁₆	Ø 30 cm	335	13 ³ / ₁₆	60.8879.3000
5,00	176	81	3 ¹ / ₁₆	Ø 40 cm	414	16 ⁷ / ₁₆	60.8879.4000



NEUTRAL

Einsatz für Chafing Dish, Insert for Chafing Dish
rund, round

Inhalt cap.		Höhe height		Ø	Ø-Außen Ø-outer		18/10
Ltr.	oz.	mm	in.	mm	mm	in.	18/10
1,50	53	50	1 ¹⁵ / ₁₆	Ø 24 cm	260	10 ¹ / ₄	12.2054.2400
5,00	176	87	3 ⁷ / ₁₆	Ø 30 cm	335	13 ⁹ / ₁₆	60.8915.3010
9,00	317	109	4 ⁵ / ₁₆	Ø 40 cm	418	16 ⁷ / ₁₆	60.8915.4000



NEUTRAL

Einsatz für Chafing Dish, Insert for Chafing Dish
rund, round

Inhalt cap.		Höhe height		Ø	Ø-Außen Ø-outer		18/10
Ltr.	oz.	mm	in.	mm	mm	in.	18/10
5,00	176	68	2 ¹¹ / ₁₆	Ø 40 cm	416	16 ³ / ₈	60.8917.4000



NEUTRAL

Speisentrennwand, Food divider
für Chafing Dish Ø 30 cm, rund, for Chafing Dish Ø 30 cm, round

Ø-Außen Ø-outer		18/10	
mm	in.	18/10	
316	12 ⁷ / ₁₆	60.8875.3000	

für Chafing Dish Ø 40 cm, rund, for Chafing Dish Ø 40 cm, round

Ø-Außen Ø-outer		18/10	
mm	in.	18/10	
400	15 ³ / ₄	60.8875.4000	

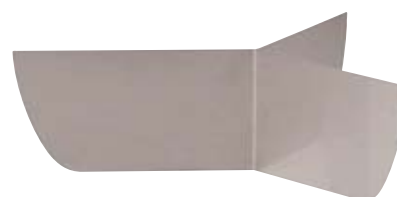

NEUTRAL

CHAFING DISH & BUFFET

Steg, Strut

Länge length				18/10 18/10
mm	in.			
325	12 ¹³ / ₁₆			60.8853.3250



NEUTRAL

Brennerhalter, Burner holder für Chafing Dish GN 1/1, for Chafing Dish GN 1/1

Länge length		Breite width		Höhe height		18/10 18/10
mm	in.	mm	in.	mm	in.	
258	10 ³ / ₁₆	200	7 ⁷ / ₈	90	3 ⁹ / ₁₆	12.2171.0000



NEUTRAL

Brennerhalter, Burner holder für Chafing Dish Ø 30 cm, Ø 40 cm, rund, for Chafing Dish Ø 30 cm, Ø 40 cm, round

Länge length		Breite width		Höhe height		18/10 18/10
mm	in.	mm	in.	mm	in.	
109	4 ⁵ / ₁₆	200	7 ⁷ / ₈	87	3 ⁷ / ₁₆	12.2171.1000



NEUTRAL

Brennpaste, Dry fuel burner

Inhalt cap.		Höhe height		18/10 18/10
Ltr.	oz.	mm	in.	
0,20	7	55	2 ³ / ₁₆	60.8960.0000



NEUTRAL

Brennerdose, Burner tin
für Brennpaste, for dry fuel burner

Ø-Außen		18/10
Ø-outer		18/10
mm	in.	
94	3 ¹¹ / ₁₆	60.8884.0000



NEUTRAL

Elektroheizung, Heating element
für Chafing Dish Ø 30 cm, rund, for Chafing Dish Ø 30 cm, round

manuell regelbar
manually adjustable

Länge length		Breite width		Heizleistung heating efficiency	Netzspannung line voltage
mm	in.	mm	in.	Watt	Volt
200	7 ⁷ / ₈	200	7 ⁷ / ₈	550	230
					60.8981.0030



NEUTRAL

Elektroheizung, Heating element
für Chafing Dish GN 1/1, Ø 40 cm, for Chafing Dish GN 1/1, Ø 40 cm

manuell regelbar
manually adjustable

Länge length		Breite width		Heizleistung heating efficiency	Netzspannung line voltage
mm	in.	mm	in.	Watt	Volt
250	9 ¹³ / ₁₆	200	7 ⁷ / ₈	700	230
					60.8981.0020



NEUTRAL

Elektroheizung, Heating element
für Chafing Dish Ø 30 cm, rund, for Chafing Dish Ø 30 cm, round

selbstregelnd
self-regulating

Länge length		Breite width		Heizleistung heating efficiency	Netzspannung line voltage
mm	in.	mm	in.	Watt	Volt
200	7 ⁷ / ₈	200	7 ⁷ / ₈	270	140/250
200	7 ⁷ / ₈	200	7 ⁷ / ₈	230	110/120
					60.8880.0030
					60.8980.0030



NEUTRAL

CHAFING DISH & BUFFET

Elektroheizung, Heating element

für Chafing Dish GN 1/1, Ø 40 cm, rund, for Chafing Dish GN 1/1, Ø 40 cm, round

selbstregelnd
self-regulating

Länge length		Breite width		Heizleistung heating efficiency	Netzspannung line voltage	
mm	in.	mm	in.	Watt	Volt	
250	9 ¹³ / ₁₆	200	7 ⁷ / ₈	325	140/250	
250	9 ¹³ / ₁₆	200	7 ⁷ / ₈	350	110/120	
					60.8880.0020	60.8980.0020

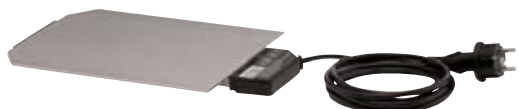

NEUTRAL

Elektroheizung, Heating element

selbstregelnd
self-regulating

Länge length		Breite width		Heizleistung heating efficiency	Netzspannung line voltage	
mm	in.	mm	in.	Watt	Volt	
250	9 ¹³ / ₁₆	200	7 ⁷ / ₈	600	140/230	
250	9 ¹³ / ₁₆	200	7 ⁷ / ₈	600	110/120	
					60.8883.0040	60.8891.0040



NEUTRAL

Centerpiece

ohne Einsätze, without inserts

Höhe height		Ø-Außen Ø-outer		18/10 Messing versilbert 18/10 brass silver-plated	
mm	in.	mm	in.		
270	10 ⁵ / ₈	530	20 ⁷ / ₈	14.4199.0000	15.5199.0000



NEUTRAL

Porzellan-Einsatz, Porcelain insert

Trapez-Form, trapezoidal

Inhalt cap.		Porzellan porcelain	
Ltr.	oz.		
0,50	18	50.8359.0000	



NEUTRAL

Porzellan-Einsatz, Porcelain insert
rund, round

Inhalt cap.		Ø-Außen Ø-outer		Porzellan porcelain
Ltr.	oz.	mm	in.	
1,00	35	170	6 ¹¹ / ₁₆	50.8358.0000



NEUTRAL

Brennerschale, Burner

18/10
18/10

12.2041.0000



NEUTRAL

CHAFING DISH & BUFFET



Servierblech, Serving tray
oval

Länge length		Breite width		18/10	versilbert silver-plated
mm	in.	mm	in.	18/10	
221	8 ¹¹ / ₁₆	156	6 ¹ / ₈	12.2032.2300	13.3032.2300
270	10 ⁹ / ₈	200	7 ⁷ / ₈	12.2032.2650	13.3032.2650
291	11 ⁷ / ₁₆	223	8 ⁹ / ₄	12.2032.2900	13.3032.2900
323	12 ¹ / ₁₆	240	9 ⁷ / ₁₆	12.2032.3200	13.3032.3200

NEUTRAL



Servierblech, Serving tray
rund, round

Ø-Außen Ø-outer		18/10	versilbert silver-plated
mm	in.	18/10	
215	8 ⁷ / ₁₆	12.2037.2000	13.3037.2000
269	10 ⁹ / ₁₆	12.2037.2600	13.3037.2600
327	12 ⁷ / ₈	12.2037.3000	13.3037.3000
369	14 ¹ / ₂	12.2037.3600	13.3037.3600
400	15 ³ / ₄	12.2037.4000	13.3037.4000

NEUTRAL



Servierblech, Serving tray

Länge length		Breite width		18/10	versilbert silver-plated
mm	in.	mm	in.	18/10	
305	12	254	10	12.2166.3050	13.3166.3050
384	15 ¹ / ₈	290	11 ⁷ / ₁₆	12.2166.3840	13.3166.3840
458	18 ¹ / ₁₆	333	13 ¹ / ₈	12.2166.4580	13.3166.4580

NEUTRAL



Bierglasträger, Tray for bottles

Ø-Außen Ø-outer		18/10
mm	in.	18/10
315	12 ³ / ₈	60.5549.3000
356	14	60.5549.3600

NEUTRAL

Ausstellplatte, Banquet tray
Gastronorm $\frac{2}{1}$

Länge length		Breite width		18/10 18/10	versilbert silver-plated
mm	in.	mm	in.		
650	25 $\frac{9}{16}$	530	20 $\frac{7}{8}$	12.2056.6500	13.3056.6500

rechteckig, ohne Abb., rectangular, without illustration

Länge length		Breite width		18/10 18/10	versilbert silver-plated
mm	in.	mm	in.		
780	30 $\frac{11}{16}$	515	20 $\frac{1}{4}$	12.2058.7500	13.3058.7500

NEUTRAL

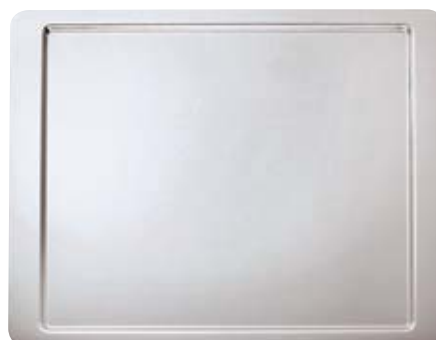

Ausstellplatte, Banquet tray
Gastronorm $\frac{1}{1}$

Länge length		Breite width		18/10 18/10	versilbert silver-plated
mm	in.	mm	in.		
530	20 $\frac{7}{8}$	325	12 $\frac{13}{16}$	12.2056.5300	13.3056.5300

NEUTRAL



Ausstellplatte, Banquet tray
Gastronorm $\frac{1}{2}$

Länge length		Breite width		18/10 18/10	versilbert silver-plated
mm	in.	mm	in.		
325	12 $\frac{13}{16}$	265	10 $\frac{7}{16}$	12.2056.3250	13.3056.3250

NEUTRAL



Ausstellplatte, Banquet tray
rechteckig, rectangular

Länge length		Breite width		18/10 18/10	versilbert silver-plated
mm	in.	mm	in.		
526	20 $\frac{11}{16}$	408	16 $\frac{1}{16}$	12.2058.5260	13.3058.5260

NEUTRAL



CHAFING DISH & BUFFET



Ausstellplatte, Banquet tray
oval

Länge length		Breite width		18/10 18/10	versilbert silver-plated
mm	in.	mm	in.		
516	20 ⁹ / ₁₆	392	15 ⁷ / ₁₆	12.2157.5200	13.3157.5200
595	23 ⁷ / ₁₆	466	18 ³ / ₈	12.2157.6000	13.3157.6000
700	27 ⁹ / ₁₆	455	17 ¹⁵ / ₁₆	12.2059.7000	13.3059.7000

NEUTRAL



Ausstellplatte, Banquet tray
rund, round

Ø-Außen Ø-outer		18/10 18/10	versilbert silver-plated
mm	in.		
425	16 ³ / ₄	12.2060.4200	13.3060.4200
500	19 ¹ / ₁₆	12.2060.5000	13.3060.5000
600	23 ⁵ / ₈	12.2060.6000	13.3060.6000

NEUTRAL



Ausstellplatte, Banquet tray
oval

Länge ohne Griffe
Length without handles

Länge length		Breite width		18/10 18/10	versilbert silver-plated
mm	in.	mm	in.		
516	20 ⁹ / ₁₆	392	15 ⁷ / ₁₆	12.4157.5200	15.5157.5200
595	23 ⁷ / ₁₆	466	18 ³ / ₈	12.4157.6000	15.5157.6000
700	27 ⁹ / ₁₆	455	17 ¹⁵ / ₁₆	12.4059.7000	15.4559.7000

EXCELLENT



Ausstellplatte, Banquet tray
oval

Länge ohne Griffe
Length without handles

Länge length		Breite width		18/10 18/10	versilbert silver-plated
mm	in.	mm	in.		
516	20 ⁹ / ₁₆	392	15 ⁷ / ₁₆	12.4857.5200	15.4857.5200
595	23 ⁷ / ₁₆	466	18 ³ / ₈	12.4857.6000	15.4857.6000
700	27 ⁹ / ₁₆	455	17 ¹⁵ / ₁₆	12.4859.7000	15.4859.7000

PROFILE

Ausstellplatte, Banquet tray
rund, round

Länge ohne Griffe
Length without handles

Ø-Außen Ø-outer		18/10	versilbert silver-plated
mm	in.		
425	16 ³ / ₄	12.4060.4200	15.4560.4200
500	19 ¹ / ₁₆	12.4060.5000	15.4560.5000
600	23 ⁵ / ₈	12.4060.6000	15.4560.6000



EXCELLENT

Ausstellplatte, Banquet tray
rund, round

Länge ohne Griffe
Length without handles

Ø-Außen Ø-outer		18/10	versilbert silver-plated
mm	in.		
425	16 ³ / ₄	12.4860.4200	15.4860.4200
500	19 ¹ / ₁₆	12.4860.5000	15.4860.5000
600	23 ⁵ / ₈	12.4860.6000	15.4860.6000



PROFILE

Ausstellplatte, Banquet tray
rechteckig, rectangular

Länge ohne Griffe
Length without handles

Länge length		Breite width		18/10	versilbert silver-plated
mm	in.	mm	in.		
530	20 ⁷ / ₈	325	12 ¹³ / ₁₆	12.4058.5300	15.4558.5300
650	25 ⁹ / ₁₆	530	20 ⁷ / ₈	12.4058.6500	15.4558.6500
780	30 ¹ / ₁₆	515	20 ¹ / ₄	12.4058.7500	15.4558.7500



EXCELLENT

Ausstellplatte, Banquet tray
rechteckig, rectangular

Länge ohne Griffe
Length without handles

Länge length		Breite width		18/10	versilbert silver-plated
mm	in.	mm	in.		
530	20 ⁷ / ₈	325	12 ¹³ / ₁₆	12.4858.5300	15.4858.5300
650	25 ⁹ / ₁₆	530	20 ⁷ / ₈	12.4858.6500	15.4858.6500
780	30 ¹ / ₁₆	515	20 ¹ / ₄	12.4858.7500	15.4858.7500



PROFILE

CHAFING DISH & BUFFET



Ausstellplatte, Banquet tray
 rechteckig, rectangular
 Länge ohne Griffe
 Length without handles

Länge length		Breite width		18/10 18/10	versilbert silver-plated
mm	in.	mm	in.		
530	20 ⁷ / ₈	325	12 ¹³ / ₁₆	12.5258.5300	13.5258.5300
650	25 ⁹ / ₁₆	530	20 ⁷ / ₈	12.5258.6500	13.5258.6500
780	30 ¹¹ / ₁₆	515	20 ¹ / ₄	12.5258.7500	13.5258.7500

ARTE



Ausstellplatte, Banquet tray
 Länge ohne Griffe
 Length without handles

Länge length		Breite width		18/10 18/10	versilbert silver-plated
mm	in.	mm	in.		
526	20 ¹¹ / ₁₆	408	16 ¹ / ₁₆	12.4058.5260	15.4558.5260

EXCELLENT



Ausstellplatte, Banquet tray
 Länge ohne Griffe
 Length without handles

Länge length		Breite width		18/10 18/10	versilbert silver-plated
mm	in.	mm	in.		
526	20 ¹¹ / ₁₆	408	16 ¹ / ₁₆	12.4858.5260	15.4858.5260

PROFILE

Plexiglashaube, Plexiglass hood

Höhe height		Ø-Außen Ø-outer		Kunststoff plastics
mm	in.	mm	in.	
216	8½	348	13⅞	60.8989.3400
288	8½	498	19⅝	60.8989.6000

Holzeinsatz, Wooden insert
für Ausstellplatte, for banquet tray
für Ausstellplatte 12.2060.4200
for banquet tray 12.2060.4200

Ø-Außen Ø-outer		Holz wood
mm	in.	
364	14⅝	60.8988.3670

für Ausstellplatte, for banquet tray
für Ausstellplatte 12.2060.6000
for banquet tray 12.2060.6000

Ø-Außen Ø-outer		Holz wood
mm	in.	
533	21	60.8988.6000



NEUTRAL

Glaseinsatz, Glass insert
für Ausstellplatte 1/1, for banquet tray 1/1

Länge length		Breite width		Höhe height		Glas glass
mm	in.	mm	in.	mm	in.	
158	6¼	92	3⅝	38	1½	50.8356.0000



NEUTRAL

Kühlset, Cooling set
3-tlg., für Ausstellplatte, 3-part, for banquet tray

Länge length		Breite width		Höhe height		18/10 18/10	versilbert silver-plated
mm	in.	mm	in.	mm	in.		
530	20⅞	325	12⅞	137	5⅝	12.2197.0000	13.3197.0000



NEUTRAL

CHAFING DISH & BUFFET

Plattenständer, Tray stand
rund für Ausstellplatte, round for banquet tray
für Ausstellplatte Ø 40 cm
for banquet tray Ø 40 cm

Höhe height		Ø-Außen Ø-outer		18/10	versilbert silver-plated
mm	in.	mm	in.	18/10	
157	6 ³ / ₁₆	385	15 ³ / ₁₆	12.3475.4200	15.3475.4200
110	4 ⁵ / ₁₆	385	15 ³ / ₁₆	12.3475.4210	15.3475.4210

rund für Ausstellplatte, round for banquet tray
für Ausstellplatte Ø 50 cm
for banquet tray Ø 50 cm

Höhe height		Ø-Außen Ø-outer		18/10	versilbert silver-plated
mm	in.	mm	in.	18/10	
157	6 ³ / ₁₆	455	17 ¹⁵ / ₁₆	12.3475.5000	15.3475.5000
110	4 ⁵ / ₁₆	455	17 ¹⁵ / ₁₆	12.3475.5010	15.3475.5010



rund für Ausstellplatte, round for banquet tray
für Ausstellplatte Ø 60 cm
for banquet tray Ø 60 cm

Höhe height		Ø-Außen Ø-outer		18/10	versilbert silver-plated
mm	in.	mm	in.	18/10	
157	6 ³ / ₁₆	550	21 ⁵ / ₈	12.3475.6000	15.3475.6000
110	4 ⁵ / ₁₆	550	21 ⁵ / ₈	12.3475.6010	15.3475.6010

EXCLUSIVE

Plattenständer, Tray stand
oval, für Ausstellplatte, oval, for banquet tray
für Ausstellplatte Ø 60 x 47 cm
for banquet tray Ø 60 x 47 cm

Länge length		Breite width		Höhe height	18/10	versilbert silver-plated
mm	in.	mm	in.	mm	18/10	
530	20 ⁷ / ₈	410	16 ¹ / ₈	157	12.3476.6000	15.3476.6000
530	20 ⁷ / ₈	410	16 ¹ / ₈	110	12.3476.6010	15.3476.6010

oval, für Ausstellplatte, oval, for banquet tray
für Ausstellplatte Ø 70 x 50 cm
for banquet tray Ø 70 x 50 cm

Länge length		Breite width		Höhe height	18/10	versilbert silver-plated
mm	in.	mm	in.	mm	18/10	
646	25 ⁷ / ₁₆	410	16 ¹ / ₈	157	12.3476.7000	15.3476.7000
646	25 ⁷ / ₁₆	410	16 ¹ / ₈	110	12.3476.7010	15.3476.7010



EXCLUSIVE

Plattenständer, Tray stand

rechteckig, für Ausstellplatte, rectangular, for banquet tray

für Ausstellplatte 53 x 32,5 cm
for banquet tray 53 x 32,5 cm

Länge length		Breite width		Höhe height		18/10	versilbert silver-plated
mm	in.	mm	in.	mm	in.	18/10	
485	19 ¹ / ₈	285	11 ¹ / ₄	157	6 ³ / ₁₆	12.3474.5300	15.3474.5300
485	19 ¹ / ₈	285	11 ¹ / ₄	110	4 ⁵ / ₁₆	12.3474.5310	15.3474.5310

rechteckig, für Ausstellplatte, rectangular, for banquet tray

für Ausstellplatte 65 x 53 cm
for banquet tray 65 x 53 cm

Länge length		Breite width		Höhe height		18/10	versilbert silver-plated
mm	in.	mm	in.	mm	in.	18/10	
560	22 ¹ / ₁₆	485	19 ¹ / ₈	157	6 ³ / ₁₆	12.3474.6500	15.3474.6500
560	22 ¹ / ₁₆	485	19 ¹ / ₈	110	4 ⁵ / ₁₆	12.3474.6510	15.3474.6510

rechteckig, für Ausstellplatte, rectangular, for banquet tray

für Ausstellplatte 75 x 53 cm
for banquet tray 75 x 53 cm

Länge length		Breite width		Höhe height		18/10	versilbert silver-plated
mm	in.	mm	in.	mm	in.	18/10	
735	28 ¹⁵ / ₁₆	470	18 ¹ / ₂	157	6 ³ / ₁₆	12.3474.7500	15.3474.7500
735	28 ¹⁵ / ₁₆	470	18 ¹ / ₂	110	4 ⁵ / ₁₆	12.3474.7510	15.3474.7510



EXCLUSIVE

Präsentationsständer, Display stand

Länge length		Breite width		Höhe height		18/10
mm	in.	mm	in.	mm	in.	18/10
183	7 ³ / ₁₆	183	7 ³ / ₁₆	80	3 ¹ / ₈	12.2175.1400
224	8 ¹³ / ₁₆	224	8 ¹³ / ₁₆	140	5 ¹ / ₂	12.2175.1900
257	10 ¹ / ₈	257	10 ¹ / ₈	180	7 ¹ / ₁₆	12.2175.2400



NEUTRAL

CHAFING DISH & BUFFET

Universalständer, Multi purpose stand
drehbar, ohne Einsätze, revolving, without inserts

Höhe height		Ø-Außen Ø-outer		18/10 18/10	versilbert silver-plated
mm	in.	mm	in.		
760	29 ¹⁵ / ₁₆	497	19 ⁹ / ₁₆	12.2358.0000	15.2358.0000



NEUTRAL

Glaseinsatz, Glass insert

Inhalt cap.		Höhe height		Ø-Außen Ø-outer		Glas glass
Ltr.	oz.	mm	in.	mm	in.	
2,00	70	105	4 ¹ / ₈	230	9 ¹ / ₁₆	50.8361.2250



NEUTRAL

Porzellan-Einsatz, Porcelain insert

Inhalt cap.		Höhe height		Ø-Außen Ø-outer		Porzellan porcelain
Ltr.	oz.	mm	in.	mm	in.	
0,80	28	88	3 ⁷ / ₁₆	145	5 ¹¹ / ₁₆	50.8362.1500



NEUTRAL

Tellerglocke, Cover
rund, round

Ø-Innen Ø-inner		18/10 18/10	versilbert silver-plated
mm	in.		
263	10 ³ / ₈	10.0507.2630	11.1507.2630
273	10 ⁹ / ₄	10.0507.2730	11.1507.2730
276	10 ⁷ / ₈	10.0507.2760	11.1507.2760
283	11 ¹ / ₈	10.0507.2830	11.1507.2830
285	11 ¹ / ₄	10.0507.2850	11.1507.2850
315	12 ³ / ₈	10.0507.3150	11.1507.3150



NEUTRAL

Tellerglocke, Cover
rund, round

Ø-Innen Ø-inner		Kunststoff plastics
mm	in.	
216	8 ¹ / ₂	41.8019.2100
261	10 ¹ / ₄	41.8019.2600
276	10 ⁷ / ₈	41.8019.2700
281	11 ¹ / ₁₆	41.8019.2800



NEUTRAL

Tellerglocke, Cover
rund, round

Ø-Innen Ø-inner		Kunststoff plastics
mm	in.	
243	9 ⁹ / ₁₆	41.8060.2430
270	10 ⁵ / ₈	41.8060.2700
280	11	41.8060.2800
283	11 ¹ / ₈	41.8060.2830
301	11 ⁷ / ₈	41.8060.3100



NEUTRAL

Lachsbrett, Salmon board

Länge length		Breite width		vernickelt nickel-plated
mm	in.	mm	in.	
890	35 ¹ / ₁₆	197	7 ³ / ₄	60.8947.0900
1180	46 ⁷ / ₁₆	234	9 ⁹ / ₁₆	60.8947.1150



NEUTRAL

CHAFING DISH & BUFFET

Escoffier 1-tlg., 1-part

Inhalt cap.		Länge length		Breite width		18/10 18/10	versilbert silver-plated
Ltr.	oz.	mm	in.	mm	in.		
2,00	70	335	13 ³ / ₁₆	267	10 ¹ / ₂	60.8802.0000	60.9002.0000



NEUTRAL

Escoffier 2-tlg., 2 part

Inhalt cap.		Länge length		Breite width		18/10 18/10	versilbert silver-plated
Ltr.	oz.	mm	in.	mm	in.		
1,60	56	335	13 ³ / ₁₆	267	10 ¹ / ₂	60.8803.0000	60.9003.0000



NEUTRAL

Deckel, Lid für Escoffier, for escoffier

Länge length		Breite width		18/10 18/10	versilbert silver-plated
mm	in.	mm	in.		
340	13 ³ / ₈	273	10 ³ / ₄	60.8804.0000	60.9004.0000



NEUTRAL

Etagere
3-tlg., 3-part

Höhe height		Ø-Außen Ø-outer		18/10 18/10	versilbert silver-plated
mm	in.	mm	in.		
622	24 ¹ / ₂	430	16 ¹⁵ / ₁₆	12.2243.4230	15.2243.4230



EXCELLENT

Etagere
3-tlg., 3-part

Höhe height		Ø-Außen Ø-outer		18/10 18/10	versilbert silver-plated
mm	in.	mm	in.		
611	24 ¹ / ₁₆	430	16 ¹⁵ / ₁₆	12.4943.4230	15.4943.4230



PROFILE

Etagere
3-tlg., 3-part

Höhe height		Ø-Außen Ø-outer		18/10 18/10	versilbert silver-plated
mm	in.	mm	in.		
645	25 ³ / ₈	430	16 ¹⁵ / ₁₆	12.3443.4230	15.3443.4230



EXCLUSIVE

CHAFING DISH & BUFFET



Etagere
5-tlg., 5-part

Höhe height		Ø-Außen Ø-outer		18/10 18/10	versilbert silver-plated
mm	in.	mm	in.		
910	35 ¹³ / ₁₆	430	16 ¹⁵ / ₁₆	12.2243.4250	15.2243.4250

EXCELLENT



Etagere
5-tlg., 5-part

Höhe height		Ø-Außen Ø-outer		18/10 18/10	versilbert silver-plated
mm	in.	mm	in.		
892	35 ¹ / ₈	430	16 ¹⁵ / ₁₆	12.4943.4250	15.4943.4250

PROFILE



Etagere
5-tlg., 5-part

Höhe height		Ø-Außen Ø-outer		18/10 18/10	versilbert silver-plated
mm	in.	mm	in.		
930	36 ⁵ / ₈	430	16 ¹⁵ / ₁₆	12.3443.4250	15.3443.4250

EXCLUSIVE

Etagere
3-tlg., drehbar, 3-part, revolving

Höhe height		Ø-Außen Ø-outer		18/10 18/10	versilbert silver-plated
mm	in.	mm	in.		
783	30 ¹³ / ₁₆	600	23 ⁵ / ₈	12.2343.6030	15.2343.6030



EXCELLENT

Etagere
3-tlg., drehbar, 3-part, revolving

Höhe height		Ø-Außen Ø-outer		18/10 18/10	versilbert silver-plated
mm	in.	mm	in.		
772	30 ⁹ / ₈	600	23 ⁵ / ₈	12.4943.6030	15.4943.6030



PROFILE

Etagere
3-tlg., drehbar, 3-part, revolving

Höhe height		Ø-Außen Ø-outer		18/10 18/10	versilbert silver-plated
mm	in.	mm	in.		
790	31 ¹ / ₈	600	23 ⁵ / ₈	12.3443.6030	15.3443.6030



EXCLUSIVE

CHAFING DISH & BUFFET



Obstschale, Fruit bowl
auf Fuß, with foot

Höhe height		Ø-Außen Ø-outer		18/10 18/10	versilbert silver-plated
mm	in.	mm	in.		
109	4 ⁵ / ₁₆	234	9 ³ / ₁₆	12.2254.2300	15.2254.2300

EXCELLENT

Obstschale, Fruit bowl

Höhe height		Ø-Außen Ø-outer		18/10 18/10	versilbert silver-plated
mm	in.	mm	in.		
84	3 ⁵ / ₁₆	225	8 ⁷ / ₈	12.4854.2300	13.4854.2300



PROFILE

Universalschale, All purpose dish

Inhalt cap.		Höhe height		Ø-Außen Ø-outer		18/10 18/10	versilbert silver-plated
Ltr.	oz.	mm	in.	mm	in.		
1,5	53	84	3 ⁵ / ₁₆	232	9 ¹ / ₈	60.5454.0000	60.7454.0000



NEUTRAL



Gerührt oder geschüttelt – immer eine Frage des persönlichen Stils

Alles für die Bar – in vollendeter Eleganz und mit unwiderstehlichem Charme. Die HEPP-Bargeräte bieten den Gourmets und Genießern außergewöhnlichen Spaß am Genuss in stilgerechtem Ambiente.

Bar-Accessoires von HEPP bereichern die Welt der professionellen Gastronomie um den Glanz der Exklusivität, die jedes einzelne dieser Objekte ausstrahlt. Funktion, Qualität und unvergleichbare Ästhetik prägen diese hochwertigen Produkte aus dem Hause HEPP rund um den Globus.



Stirred or shaken – it's always a question of taste

We have everything for the bar – in perfect elegance and irresistible charm. HEPP's bar utensils offer gourmets and connoisseurs extraordinary enjoyment in a stylish ambience.

Bar accessories from HEPP enhance the world of the professional caterer with the gleam of exclusivity radiating from every single article. Function, quality and incomparable aesthetics characterize these valuable HEPP products all round the globe.



BAR



BAR



Barkoffer, Bar set
komplett, complete

Länge length		Breite width		
mm	in.	mm	in.	
463	18 ¹ / ₄	359	14 ¹ / ₈	60.5400.0000

NEUTRAL

Barlöffel, Bar spoon

Länge length		
mm	in.	
258	10 ³ / ₁₆	18/10 60.8943.0000

Barmesser, Bar knife



Länge length		
mm	in.	
223	8 ³ / ₄	18/10 18/10 60.5437.0000

NEUTRAL

Alkoholmeßbecher, Measure for liquor

Inhalt cap.		Höhe height		Ø-Außen Ø-outer		18/10 18/10	versilbert silver-plated
Ltr.	oz.	mm	in.	mm	in.		
0,04	1,41	40	1 ⁹ / ₁₆	45	1 ³ / ₄	12.2126.0040	13.3126.0040

für: 0,02 ltr., 0,04 ltr., for: 0,70 oz, 1,41 oz



Höhe height			18/10 18/10	versilbert silver-plated
mm	in.			
85	3 ³ / ₈	60.5482.0000	60.7482.0000	

NEUTRAL

Bitterflasche, Bitter bottle



Inhalt cap.		Höhe height		Ø-Außen Ø-outer		Glas glass
Ltr.	oz.	mm	in.	mm	in.	
0,35	12	193	7 ⁵ / ₈	91	3 ⁹ / ₁₆	60.5473.0000

NEUTRAL

Cocktailbecher, Cocktail shaker

Inhalt cap.		Höhe height		18/10	versilbert silver-plated
Ltr.	oz.	mm	in.	18/10	
0,30	11	177	6 ¹⁵ / ₁₆	60.9044.0350	60.9144.0350
0,60	21	235	9 ¹ / ₄	60.9044.0000	60.9144.0000



NEUTRAL

Cocktailsieb, Cocktail strainer

Länge length		18/10	versilbert silver-plated
mm	in.	18/10	
197	7 ³ / ₄	60.9045.0000	60.9145.0000



NEUTRAL

Boston Shaker, Boston shaker mit Rührglas, with mixing glass

Inhalt cap.		18/10
Ltr.	oz.	18/10
0,60	21	60.5439.0000



NEUTRAL

Rührglas, Mixing glass

Inhalt cap.		Glas glass
Ltr.	oz.	
0,40	14	50.8355.0000



NEUTRAL

Sektflaschenverschluß, Champagne stopper

Länge length		vernickelt nickel-plated
mm	in.	
55	2 ³ / ₁₆	60.5434.0000



NEUTRAL

Barzange, Bar tongs

Länge length		vernickelt nickel-plated
mm	in.	
172	6 ³ / ₄	60.5435.0000



NEUTRAL

Flaschenöffner, Bottle opener

Länge length		18/10 18/10
mm	in.	
154	6 ¹ / ₁₆	60.5431.0000



NEUTRAL

Korkenzieher, Corkscrew

Länge length		verchromt chrome
mm	in.	
140	5 ¹ / ₂	60.5432.0000



NEUTRAL

Zigarrenabschneider, Cigar cutter

Länge length		vernickelt nickel-plated
mm	in.	
156	6 ¹ / ₈	60.8836.0000



NEUTRAL

Kellnermesser, Waiter's knife

Länge length		18/10
mm	in.	18/10
141	5 ⁹ / ₁₆	60.8946.0000



NEUTRAL

Roheisschaufel, Ice shovel

Länge length		18/10	versilbert silver-plated
mm	in.	18/10	
165	6 ¹ / ₂	12.5015.0000	13.6015.0000



NEUTRAL

Roheishammer, Ice hammer

Länge length		18/10	versilbert silver-plated
mm	in.	18/10	
189	7 ⁷ / ₁₆	12.2047.0000	13.3047.0000



NEUTRAL

BAR

Roheiszange, Ice tongs

Länge length		18/10	versilbert silver-plated
mm	in.		
156	6 ¹ / ₈	60.8834.0000	60.9034.0000
100	3 ¹⁵ / ₁₆	60.8834.1000	60.9034.1000



NEUTRAL

Bar-Zitronenpresse, Lemon squeezer for bar

Ø-Außen Ø-outer		18/10	versilbert silver-plated
mm	in.		
132	5 ³ / ₁₆	60.5413.0000	60.7413.0000



NEUTRAL

Zitronenpresse, Lemon squeezer

Länge length		Breite width		18/10	versilbert silver-plated
mm	in.	mm	in.	18/10	
82	3 ¹ / ₄	69	2 ¹¹ / ₁₆	60.8828.0000	60.9028.0000



NEUTRAL

Muskatreibe, Nutmeg grater

Länge length		vernickelt nickel-plated
mm	in.	
160	6 ⁵ / ₁₆	60.5414.0000

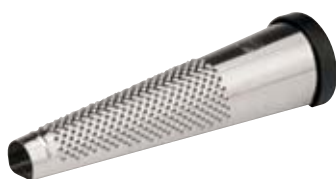

NEUTRAL

Barstände, Snack stand
3-tlg., 3-part

Höhe height		18/10	versilbert silver-plated
mm	in.		
247	9 ³ / ₄	12.2235.0000	15.2235.0000



EXCELLENT

Barstände, Snack stand

Höhe height		18/10	versilbert silver-plated
mm	in.		
251	9 ⁷ / ₈	12.3435.0000	15.3435.0000



EXCLUSIVE

Barstände, Snack stand
3-tlg., 3-part

Höhe height		18/10	versilbert silver-plated
mm	in.		
163	6 ⁷ / ₁₆	12.4837.0000	15.4837.0000



PROFILE

Barstände, Snack stand
3-tlg., 3-part

Höhe height		18/10	versilbert silver-plated
mm	in.		
168	6 ⁵ / ₈	12.2237.0000	15.2237.0000



EXCELLENT

BAR

Barständer, Snack stand
3-tlg., 3-part



Höhe height		18/10 18/10	versilbert silver-plated
mm	in.		
163	6 ⁷ / ₁₆	12.5237.0000	15.5237.0000

ARTE

Barständer, Snack stand
4-tlg., 4-part



Höhe height		18/10 18/10	versilbert silver-plated
mm	in.		
228	9	12.2236.0000	15.2236.0000

EXCELLENT

Zigarrenständer, Cigar stand



Höhe height		18/10 18/10	versilbert silver-plated
mm	in.		
110	4 ⁵ / ₁₆	12.2470.0000	13.2470.0000

NEUTRAL

Fidibusständer, Fidibus stand



Höhe height		18/10 18/10	versilbert silver-plated
mm	in.		
124	4 ⁷ / ₈	12.2471.0000	13.2471.0000

NEUTRAL

Flaschen-Gläserteller, Bottle and glass tray

Ø-Außen Ø-outer		18/10 18/10	versilbert silver-plated
mm	in.		
101	4	10.0609.1000	11.1609.1000
142	5 ⁹ / ₁₆	10.0609.1400	11.1609.1400



NEUTRAL

Strohalmbecher, Straw holder

Höhe height		18/10 18/10	versilbert silver-plated
mm	in.		
145	5 ¹¹ / ₁₆	12.2225.0000	13.2225.0000



NEUTRAL

Zahnstocherbehälter, Toothpick stand

Höhe height		18/10 18/10	versilbert silver-plated
mm	in.		
80	3 ¹ / ₈	12.2231.0000	13.2231.0000



NEUTRAL

Schneidbrett, Cutting board

Länge length		Breite width		Kunststoff plastics
mm	in.	mm	in.	
400	15 ³ / ₄	250	9 ¹³ / ₁₆	60.5333.4000
500	19 ¹¹ / ₁₆	300	11 ¹³ / ₁₆	60.5333.5000



NEUTRAL

BAR

Aschenbecher, Ash tray

Ø-Außen
Ø-outer

18/10
18/10

mm in.

100 3¹⁵/₁₆

60.5548.1000



NEUTRAL

KALTGERÄTKE · COLD DRINKS



Weinkühler, Wine cooler
für 2 Flaschen, for 2 bottles

Höhe height		Ø-Außen Ø-outer		18/10 18/10	versilbert silver-plated
mm	in.	mm	in.		
247	9 ³ / ₄	231	9 ¹ / ₈	12.4018.2310	15.4518.2300



EXCELLENT

Weinkühler, Wine cooler
für 2 Flaschen, for 2 bottles

Höhe height		Ø-Außen Ø-outer		18/10 18/10	versilbert silver-plated
mm	in.	mm	in.		
247	9 ³ / ₄	231	9 ¹ / ₈	12.4818.2310	15.4818.2300



PROFILE

Weinkühler, Wine cooler
für 2 Flaschen, for 2 bottles

Höhe height		Ø-Außen Ø-outer		18/10 18/10	versilbert silver-plated
mm	in.	mm	in.		
247	9 ³ / ₄	231	9 ¹ / ₈	12.3418.2310	15.3418.2300



EXCLUSIVE

Weinkühler, Wine cooler
für 2 Flaschen, for 2 bottles

Höhe height		Ø-Außen Ø-outer		18/10 18/10	versilbert silver-plated
mm	in.	mm	in.		
247	9 ³ / ₄	231	9 ¹ / ₈	12.5218.2310	15.5218.2300



ARTE

KALTGERÄTKE · COLD DRINKS



Weinkühler, Wine cooler
für 1 Flasche, for 1 bottle

Höhe height		Ø-Außen Ø-outer		18/10 18/10	versilbert silver-plated
mm	in.	mm	in.		
219	8 ⁵ / ₈	189	7 ⁷ / ₁₆	12.4018.1910	15.4518.1900

EXCELLENT



Weinkühler, Wine cooler
für 1 Flasche, for 1 bottle

Höhe height		Ø-Außen Ø-outer		18/10 18/10	versilbert silver-plated
mm	in.	mm	in.		
219	8 ⁵ / ₈	189	7 ⁷ / ₁₆	12.4818.1910	15.4818.1900

PROFILE



Weinkühler, Wine cooler
für 1 Flasche, for 1 bottle

Höhe height		Ø-Außen Ø-outer		18/10 18/10	versilbert silver-plated
mm	in.	mm	in.		
219	8 ⁵ / ₈	189	7 ⁷ / ₁₆	12.3418.1910	15.3418.1900

EXCLUSIVE



Weinkühler, Wine cooler
für 1 Flasche, for 1 bottle

Höhe height		Ø-Außen Ø-outer		18/10 18/10	versilbert silver-plated
mm	in.	mm	in.		
219	8 ⁵ / ₈	189	7 ⁷ / ₁₆	12.5218.1910	15.5218.1900

ARTE

Weinkühler, Wine cooler
für 1 Flasche, for 1 bottle

Höhe height		Ø-Außen Ø-outer		18/10 18/10	versilbert silver-plated
mm	in.	mm	in.		
210	8¼	168	6⅝	12.2318.1610	15.2318.1600



EXCELLENT

Weinkühler, Wine cooler
für 1 Flasche, for 1 bottle

Höhe height		Ø-Außen Ø-outer		18/10 18/10	versilbert silver-plated
mm	in.	mm	in.		
210	8¼	168	6⅝	12.4818.1610	15.4818.1600



PROFILE

Weinkühler, Wine cooler
für 1 Flasche, for 1 bottle

Höhe height		Ø-Außen Ø-outer		18/10 18/10	versilbert silver-plated
mm	in.	mm	in.		
210	8¼	168	6⅝	12.3418.1610	15.3418.1600



EXCLUSIVE

Weinkühler, Wine cooler
für 1 Flasche, for 1 bottle

Höhe height		Ø-Außen Ø-outer		18/10 18/10	versilbert silver-plated
mm	in.	mm	in.		
210	8¼	168	6⅝	12.5218.1610	15.5218.1600



ARTE

KALTGERÄTKE · COLD DRINKS



Weinkühler, Wine cooler
oval, für 2 Flaschen, oval, for 2 bottles

Länge length		Breite width		Höhe height		18/10 18/10	versilbert silver-plated
mm	in.	mm	in.	mm	in.		
265	10 ⁷ / ₁₆	223	8 ³ / ₄	210	8 ¹ / ₄	12.2233.2710	15.2233.2710

EXCELLENT



Flaschenkühler, Bottle-cooler
isoliert, insulated

Höhe height		Ø-Außen Ø-outer		18/10 18/10
mm	in.	mm	in.	
179	7 ¹ / ₁₆	121	4 ³ / ₄	60.5449.0000

NEUTRAL



Flaschenhalter, Bottle holder

Ø-Außen Ø-outer		18/10 18/10	versilbert silver-plated
mm	in.		
79	3 ¹ / ₈	12.4947.0000	13.4947.0000

NEUTRAL

Weinkühlerständer, Stand for wine cooler

für 1 Flasche
for 1 bottle

Höhe height		Ø-Innen Ø-inner		18/10 18/10	versilbert silver-plated
mm	in.	mm	in.		
676	26 ⁵ / ₈	162	6 ³ / ₈	12.2255.6860	13.2255.6860

für 2 Flaschen
for 2 bottles

Höhe height		Ø-Innen Ø-inner		18/10 18/10	versilbert silver-plated
mm	in.	mm	in.		
688	27 ¹ / ₁₆	180	7 ¹ / ₁₆	12.2255.6880	13.2255.6880



EXCELLENT

Weinkühlerständer, Stand for wine cooler

für 1 Flasche
for 1 bottle

Höhe height		Ø-Innen Ø-inner		18/10 18/10	versilbert silver-plated
mm	in.	mm	in.		
676	26 ⁵ / ₈	162	6 ³ / ₈	12.4855.6860	13.4855.6860

für 2 Flaschen
for 2 bottles

Höhe height		Ø-Innen Ø-inner		18/10 18/10	versilbert silver-plated
mm	in.	mm	in.		
688	27 ¹ / ₁₆	180	7 ¹ / ₁₆	12.4855.6880	13.4855.6880



PROFILE

Weinkühlerständer, Stand for wine cooler

für 1 Flasche
for 1 bottle

Höhe height		Ø-Innen Ø-inner		18/10 18/10	versilbert silver-plated
mm	in.	mm	in.		
676	26 ⁵ / ₈	162	6 ³ / ₈	12.5255.6860	13.5255.6860

für 2 Flaschen, for 2 bottles

für 2 Flaschen
for 2 bottles

Höhe height		Ø-Innen Ø-inner		18/10 18/10	versilbert silver-plated
mm	in.	mm	in.		
688	27 ¹ / ₁₆	180	7 ¹ / ₁₆	12.5255.6880	13.5255.6880



ARTE

KALTGERÄTKE · COLD DRINKS

Weinkühlerständer, Stand for wine cooler
oval



Länge length		Breite width		Höhe height		18/10 18/10	versilbert silver-plated
mm	in.	mm	in.	mm	in.		
239	9 ⁷ / ₁₆	173	6 ¹³ / ₁₆	671	26 ⁷ / ₁₆	12.2234.0000	13.2234.0000

EXCELLENT

Rotweingestell, Red wine holder

für Flasche 0,375 ltr., 0,75 ltr., 1,50 ltr.
for bottle 13 oz, 26 oz, 53 oz



Länge length		Breite width		18/10 18/10	versilbert silver-plated
mm	in.	mm	in.		
315	12 ³ / ₈	138	5 ⁷ / ₁₆	12.2296.0000	13.2296.0000

NEUTRAL

Rotweinkorb, Wine basket

für Flasche 0,375 ltr.
for bottle 13 oz

Länge length		Breite width		versilbert silver-plated
mm	in.	mm	in.	
215	8 ⁷ / ₁₆	110	4 ⁵ / ₁₆	60.9186.0370

für Flasche 0,75 ltr.
for bottle 26 oz



Länge length		Breite width		versilbert silver-plated
mm	in.	mm	in.	
248	9 ³ / ₄	110	4 ⁵ / ₁₆	60.9186.0750

NEUTRAL

Champagnerschüssel, Champagne bowl
ohne Einsatzring, without ring for glass insert

Inhalt cap.		Höhe height		Ø-Außen Ø-outer		18/10 18/10	versilbert silver-plated
Ltr.	oz.	mm	in.	mm	in.		
13,00	458	300	11 ¹³ / ₁₆	385	15 ³ / ₁₆	12.2275.3700	15.2275.3700



EXCELLENT

Champagnerschüssel, Champagne bowl
ohne Einsatzring, without ring for glass insert

Inhalt cap.		Höhe height		Ø-Außen Ø-outer		18/10 18/10	versilbert silver-plated
Ltr.	oz.	mm	in.	mm	in.		
13,00	458	303	11 ¹⁵ / ₁₆	385	15 ³ / ₁₆	12.4875.3700	13.4875.3700



PROFILE

Champagnerschüssel, Champagne bowl
ohne Einsatzring, without ring for glass insert

Inhalt cap.		Höhe height		Ø-Außen Ø-outer		18/10 18/10	versilbert silver-plated
Ltr.	oz.	mm	in.	mm	in.		
13,00	458	303	11 ¹⁵ / ₁₆	385	15 ³ / ₁₆	12.5275.3700	13.5275.3700



ARTE

Ring für Gläser, Ring for glasses

Höhe height		Ø-Außen Ø-outer		18/10 18/10	versilbert silver-plated
mm	in.	mm	in.		
100	3 ¹⁵ / ₁₆	402	15 ¹³ / ₁₆	12.2190.3700	13.3190.3700



NEUTRAL

KALTGERÄTKE · COLD DRINKS

Glaseinsatz, Glass insert
für Eisfrucht, for iced fruit

Inhalt cap.		Höhe height		Ø-Außen Ø-outer		Glas glass
Ltr.	oz.	mm	in.	mm	in.	
8,00	282	168	6 ⁵ / ₈	314	12 ³ / ₈	50.8357.0000



NEUTRAL

Ring für Glaseinsatz, Insert

Höhe height		Ø-Außen Ø-outer		18/10	versilbert silver-plated
mm	in.	mm	in.	18/10	
135	5 ⁵ / ₁₆	410	16 ¹ / ₈	12.2042.0000	13.3042.0000



NEUTRAL

Eiswasserkanne, Water pitcher
mit Eislippe, with ice-lip

Inhalt cap.		18/10		versilbert silver-plated
Ltr.	oz.	18/10		
1,50	53	60.5461.0000	60.7461.0000	



NEUTRAL

Eiswasserkanne, Water pitcher

Inhalt cap.		18/10		versilbert silver-plated
Ltr.	oz.	18/10		
2,00	70	12.4404.2000	13.4404.2000	



PROFILE

Eiswasserkanne, Water pitcher
mit Eislippe, with ice-lip

Inhalt cap.		18/10 18/10	versilbert silver-plated
Ltr.	oz.		
2,00	70	12.4408.2000	13.4408.2000



PROFILE

Eiswasserkanne, Water pitcher

Inhalt cap.		18/10 18/10	versilbert silver-plated
Ltr.	oz.		
2,00	70	12.5227.2000	13.5227.2000



ARTE

Eiswasserkanne, Water pitcher
mit Eislippe, with ice-lip

Inhalt cap.		18/10 18/10	versilbert silver-plated
Ltr.	oz.		
2,00	70	12.2108.2000	13.3108.2000



EXCELLENT

Eiswasserkanne, Water pitcher

Inhalt cap.		18/10 18/10	versilbert silver-plated
Ltr.	oz.		
2,00	70	12.2104.2000	13.3104.2000



EXCELLENT

KALTGERÄTKE · COLD DRINKS



Eiswasserkanne, Water pitcher
mit Eislippe, with ice-lip

Inhalt cap.		18/10 18/10	versilbert silver-plated
Ltr.	oz.		
1,50	53	12.2208.1500	13.2208.1500

AVANTGARDE



Eiswasserkanne, Water pitcher

Inhalt cap.		18/10 18/10	versilbert silver-plated
Ltr.	oz.		
1,50	53	12.2203.1500	13.2203.1500

AVANTGARDE



Eiswasserkanne, Ice water pitcher
doppelwandig, double walled

Inhalt cap.		18/10 18/10
Ltr.	oz.	
1,80	66	60.5331.1800

NEUTRAL



Roheisbehälter, Ice bucket
doppelwandig, double walled

Höhe height		Ø-Außen Ø-outer		18/10 18/10
mm	in.	mm	in.	
194	7 ⁵ / ₈	148	5 ¹³ / ₁₆	60.5497.0000

EXCELLENT

Roheisbehälter, Ice bucket
doppelwandig, double walled

Höhe height		Ø-Außen Ø-outer		18/10 18/10
mm	in.	mm	in.	
191	7½	148	5 ¹³ / ₁₆	12.4997.0000



PROFILE

Roheisbehälter, Ice bucket
doppelwandig, double walled

Höhe height		Ø-Außen Ø-outer		18/10 18/10
mm	in.	mm	in.	
191	7½	148	5 ¹³ / ₁₆	12.5297.0000



ARTE

Roheisbehälter, Ice bucket
mit Roheiszange
with ice tongs

Höhe height		Ø-Außen Ø-outer		18/10 18/10
mm	in.	mm	in.	
230	9 ¹ / ₁₆	131	5 ³ / ₁₆	60.5491.0000



NEUTRAL

Roheisbehälter, Ice bucket

Höhe height		Ø-Außen Ø-outer		18/10 18/10	versilbert silver-plated
mm	in.	mm	in.		
121	4¾	126	4 ¹⁵ / ₁₆	12.2219.0000	15.2219.0000



EXCELLENT

KALTGERÄTKE · COLD DRINKS

Roheisbehälter, Ice bucket

Höhe height		Ø-Außen Ø-outer		18/10 18/10	versilbert silver-plated
mm	in.	mm	in.		
121	4¾	126	4 ¹⁵ / ₁₆	12.4919.0000	15.4919.0000



PROFILE

Roheisbehälter, Ice bucket

Höhe height		Ø-Außen Ø-outer		18/10 18/10	versilbert silver-plated
mm	in.	mm	in.		
121	4¾	126	4 ¹⁵ / ₁₆	12.5319.0000	15.5319.0000



ARTE

Roheisbehälter, Ice bucket

Höhe height		Ø-Außen Ø-outer		18/10 18/10	versilbert silver-plated
mm	in.	mm	in.		
121	4¾	126	4 ¹⁵ / ₁₆	60.5419.0000	60.7419.0000



NEUTRAL



Die Kunst, Genuss glanzvoll zu präsentieren

Mit den Servierwagen von HEPP setzen Gastgeber kulinarische Höhepunkte und visuelle Highlights. Die modernen und funktionalen Modelle fügen sich nahtlos ins stilvolle Interieur von Hotels und Restaurants ein. Ein Wagen, viele Funktionen: Die Basismodelle lassen sich durch verschiedene Varianten und Aufsätze verwandeln. Ob als Digestif-, Humidor-, Induktions-, Flambier- oder Rinderbrustwagen – dem kulinarischen Angebot und den Einsatzmöglichkeiten sind kaum Grenzen gesetzt.

The art of glamorous food presentation

With the serving trolley HEPP provides the caterer with a culinary and visual focal point. The modern and functional models blend in effortlessly with the stylish interior of the design worlds of hotels and restaurants. One trolley, numerous functions: The basic models can be transformed with different modifications and attachments. Whether as a trolley for after dinner drinks, as a humidor, for induction, for serving flambé food or roast beef, there are no limits to the culinary choice and different uses.



SERVIERWAGEN · SERVING TROLLEY



FARBEN · COLOURS



001 Kirsch, Holz furniert
001 Cherry, Wood veneered

Farben Nr. 006, 008, 009, 010, 011
und Sonderfarben sind gegen
Aufpreis erhältlich.

Colours No. 006, 008, 009, 010, 011
and special colours are available
for an extra charge.



002 Mahagoni, Holz furniert
002 Mahogany, Wood veneered

Die abgebildeten Farben sind unverbindlich.
Unregelmäßigkeiten in Farbe und Maserung
sind möglich.

The shown colours are without obligation.
Irregularities of the colours and the grain
are possible.



003 Palisander, Holz furniert
003 Rosewood, Wood veneered



004 Nuss dunkel, Holz furniert
004 Nut dark, Wood veneered



005 Nuss hell, Holz furniert
005 Nut light, Wood veneered



006 Weiß, Holz furniert
006 White, Wood veneered



008 Bordeaux, Holz furniert
008 Bordeaux, Wood veneered



009 Grün, Holz furniert
009 Green, Wood veneered

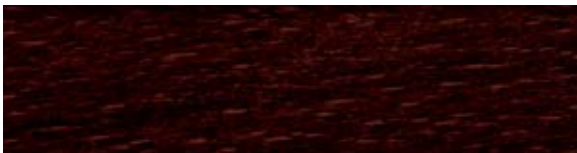

011 Venghe, Holz furniert
011 Venghe, Wood veneered



010 Schwarz, Holz furniert
010 Black, Wood veneered

SERVIERWAGEN · SERVING TROLLEY



Digestifwagen, Liquor trolley

Edelholzrahmen, Digestifaufsatz, ausziehbare Arbeitsplatte.

Unit made of finest quality natural wood, top for alcoholic beverages, sliding shelf.

Länge length		Breite width		Höhe height		
mm	in.	mm	in.	mm	in.	
1030	40 ⁹ / ₁₆	540	21 ¹ / ₄	910	35 ¹³ / ₁₆	30.7901.0000



ELEGANCE

Sorbetwagen, Sorbet trolley

Edelholzrahmen, Sorbetaufsatz, ohne Sorbetbehälter, Digestifaufsatz, ausziehbare Arbeitsplatte.

Unit made of finest quality natural wood, top for sorbets, without sorbet pots, top for alcoholic beverages, sliding shelf.

Länge length		Breite width		Höhe height		
mm	in.	mm	in.	mm	in.	
1030	40 ⁹ / ₁₆	540	21 ¹ / ₄	890	35 ¹ / ₁₆	30.7903.0000



ELEGANCE

SERVIERWAGEN · SERVING TROLLEY

Weinwagen, Wine trolley

Edelholzrahmen, Glashalter, Isolierbehälter für Weinflaschen, ausziehbare Arbeitsplatte und Schublade.

Unit made of finest quality natural wood, glass holder, isolated containers for wine bottles, sliding shelf and drawer.



Länge length		Breite width		Höhe height		
mm	in.	mm	in.	mm	in.	
1030	40 ⁹ / ₁₆	540	21 ¹ / ₄	890	35 ¹ / ₁₆	30.7928.0000

ELEGANCE

Flaschenträger für 6 Flaschen, Holder for 6 bottles

Länge length		Breite width		Höhe height		
mm	in.	mm	in.	mm	in.	
1030	40 ⁹ / ₁₆	540	21 ¹ / ₄	890	35 ¹ / ₁₆	30.7928.0010



ELEGANCE

Humidorwagen, Cigar trolley

Edelholzrahmen, Digestifaufsatz mit Glashalter, 2 Zigarrenfächer mit Befeuchter und Hygrometer, abschließbar, ausziehbare Arbeitsplatte.

Unit made of finest quality natural wood, top for alcoholic beverages with glass holder, 2 compartments for cigars with moistener and hygrometer, lockable, sliding shelf.

Länge length		Breite width		Höhe height		
mm	in.	mm	in.	mm	in.	
1030	40 ⁹ / ₁₆	540	21 ¹ / ₄	890	35 ¹ / ₁₆	30.7927.0000



ELEGANCE

Servierwagen - Grundmodell, Serving trolley - basic model

Grundmodell für alle Aufsätze, Edelholzrahmen, ausziehbare Arbeitsplatte.

Basic model for all tops, unit made of finest quality natural wood, sliding shelf.

Länge length		Breite width		Höhe height		
mm	in.	mm	in.	mm	in.	
1030	40 ⁹ / ₁₆	540	21 ¹ / ₄	810	31 ⁷ / ₈	30.7900.0000



ELEGANCE

SERVIERWAGEN · SERVING TROLLEY

Kuchen- und Nachspeisewagen, Pastry and dessert trolley

Edelholzrahmen, Kühlaufsatz 18/10 mit 2 Kühlpellets, Plexiglashaube, ausziehbare Arbeitsplatte.

Unit made of finest quality natural wood, top 18/10 for cooling with 2 cooling pellets, plexiglass hood, sliding shelf.



Länge length		Breite width		Höhe height		30.7902.0000
mm	in.	mm	in.	mm	in.	
1030	40 ⁹ / ₁₆	540	21 ¹ / ₄	870	34 ¹ / ₄	

ELEGANCE

Kuchen- und Nachspeisewagen, Pastry and dessert trolley

Edelholzrahmen mit Plexiglashaube, umluftgekühlt, thermostatisch regelbar, ausziehbare Arbeitsplatte.

Unit made of finest quality natural wood, with plexiglass hood, recirculating cooling, thermostatically adjustable, sliding shelf.



Länge length		Breite width		Höhe height		Netzspannung line voltage	30.7916.0000
mm	in.	mm	in.	mm	in.	Volt	
1030	40 ⁹ / ₁₆	540	21 ¹ / ₄	890	35 ¹ / ₁₆	220	

ELEGANCE

Meeresfrüchtewagen, Seafood trolley

Edelholzrahmen, Holzaufsatz mit Roheiswanne 18/10, ausziehbare Arbeitsplatte.

Unit made of finest quality natural wood, wooden top with container 18/10 for ice, sliding shelf.

Länge length		Breite width		Höhe height		30.7905.0000
mm	in.	mm	in.	mm	in.	
1030	40 ⁹ / ₁₆	540	21 ¹ / ₄	890	35 ¹ / ₁₆	



ELEGANCE

Käsewagen, Cheese trolley

Edelholzrahmen, Käseaufsatz mit halbbrollender Plexiglashaube, Kunstmarmorplatte, ausziehbare Arbeitsplatte.

Unit made of finest quality natural wood, top for cheese, with roll top plexiglass hood, artificial marble plate, sliding shelf.

Länge length		Breite width		Höhe height		30.7914.0000
mm	in.	mm	in.	mm	in.	
1030	40 ⁹ / ₁₆	540	21 ¹ / ₄	1060	41 ³ / ₄	



ELEGANCE

SERVIERWAGEN · SERVING TROLLEY

Induktionswagen, Induction trolley

Edelholzrahmen mit Induktionsherd, Flaschenhalter, ausziehbare Arbeitsplatte und Schublade.

Unit made of finest quality natural wood, with induction stove, bottle holder, sliding shelf and drawer.

Länge length		Breite width		Höhe height		Netzspannung line voltage
mm	in.	mm	in.	mm	in.	Volt
1030	40 ⁹ / ₁₆	540	21 ¹ / ₄	890	35 ¹ / ₁₆	230
30.7926.0000						



ELEGANCE

Flambierwagen, Flambé trolley

Edelholzrahmen, mit Züandsicherung und Magnetzündung, Arbeitsfläche Kunstmarmorplatte, Flaschenhalter, ohne Gasflasche, propangasbeheizt, einflammig

Unit made of finest quality natural wood, with safety pilot and magneto ignition, artificial marble plate for working, bottle holder, without gas bottle, propane gas heating, 1 flame

Länge length		Breite width		Höhe height	
mm	in.	mm	in.	mm	in.
1030	40 ⁹ / ₁₆	540	21 ¹ / ₄	810	31 ⁷ / ₈
30.7913.0000					



ELEGANCE

Chafing Dish Wagen, Chafing Dish trolley

Edelholzrahmen, ganz rollende Haube 18/10, Ablage für Tranchierbesteck und klappbare Abstellplatte, elektrisch beheizbar, ohne Elektroheizung, ohne Einsätze

Unit made of finest quality natural wood, full roll top cover 18/10, basin for the cutlery and hinged side plate, for electric heating, without electric heating element, without inserts

Elektroheizung 60.8981.0020, Seite 143
 Heating element 60.8981.0020, page 143
 Elektroheizung 60.8880.0020, Seite 144
 Heating element 60.8880.0020, page 144

Länge length		Breite width		Höhe height		
mm	in.	mm	in.	mm	in.	
1030	40 ⁹ / ₁₆	540	21 ¹ / ₄	995	39 ⁹ / ₁₆	30.7929.0000



ELEGANCE

Rinderbrustwagen, Roast beef trolley

Edelholzrahmen, ganz rollende Haube 18/10, klappbare Abstellplatte, abnehmbare Halterung für Tranchierbesteck., elektrisch beheizt

Unit made of finest quality natural wood, full roll top cover 18/10, hinged side plate, removable holder for carving set., electric heating

Länge length		Breite width		Höhe height		Netzspannung line voltage	
mm	in.	mm	in.	mm	in.	Volt	
1080	42 ¹ / ₂	610	24	1040	40 ¹⁵ / ₁₆	220	30.7907.0000
1080	42 ¹ / ₂	610	24	1040	40 ¹⁵ / ₁₆	110	30.7907.1000



ELEGANCE

SERVIERWAGEN · SERVING TROLLEY

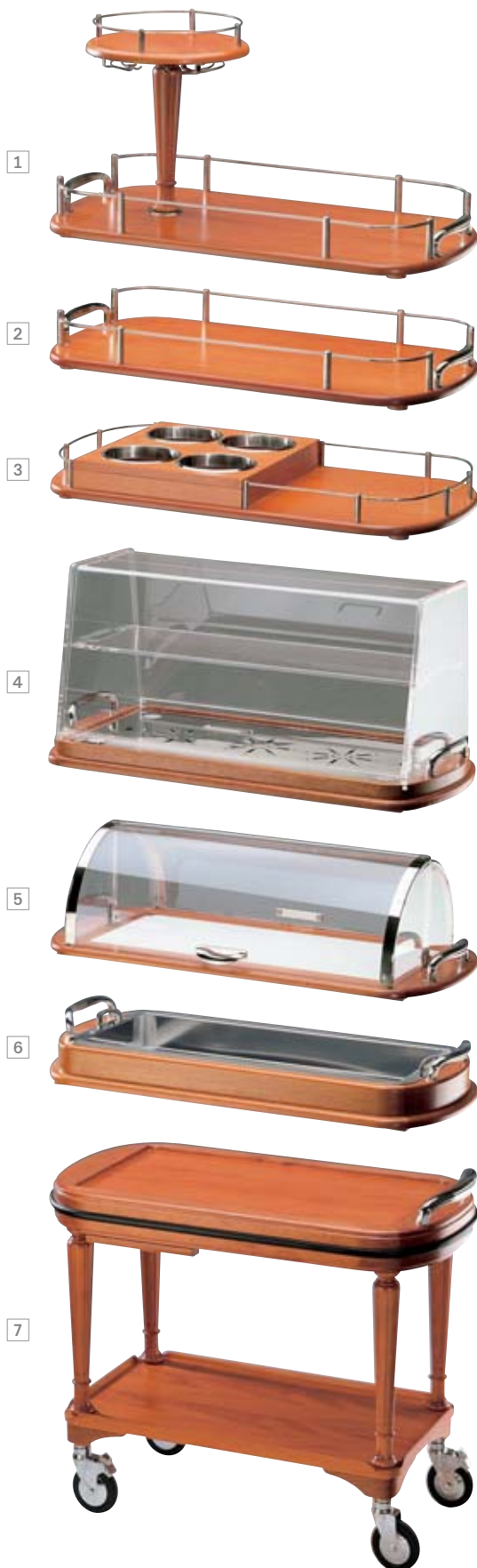

1 Digestifaufsatz mit Glashalter, Top for alcoholic beverages with glass holder

Länge length		Breite width		Höhe height		
mm	in.	mm	in.	mm	in.	
920	36 ¹ / ₄	460	18 ¹ / ₈	420	16 ⁹ / ₁₆	30.7908.0010

2 Digestifaufsatz, Top for alcoholic beverages

Länge length		Breite width		Höhe height		
mm	in.	mm	in.	mm	in.	
920	36 ¹ / ₄	460	18 ¹ / ₈	100	3 ⁹ / ₁₆	30.7901.0010

3 Sorbetaufsatz, Top for sorbets

Länge length		Breite width		Höhe height		
mm	in.	mm	in.	mm	in.	
920	36 ¹ / ₄	460	18 ¹ / ₈	80	3 ¹ / ₈	30.7903.0010

4 Kühlaufsatz mit Plexiglashaube, Top for cooling with plexiglass hood

Länge length		Breite width		Höhe height		
mm	in.	mm	in.	mm	in.	
920	36 ¹ / ₄	460	18 ¹ / ₈	430	16 ¹⁵ / ₁₆	30.7902.0010

5 Käseaufsatz, Top for cheese

Länge length		Breite width		Höhe height		
mm	in.	mm	in.	mm	in.	
920	36 ¹ / ₄	460	18 ¹ / ₈	250	9 ¹³ / ₁₆	30.7914.0010

6 Meeresfrüchteaufsatz, Top for seafood

Länge length		Breite width		Höhe height		
mm	in.	mm	in.	mm	in.	
920	36 ¹ / ₄	460	18 ¹ / ₈	80	3 ¹ / ₈	30.7905.0010

7 Servierwagen - Grundmodell, Serving trolley - basic model

Grundmodell für alle Aufsätze, Edelholzrahmen, ausziehbare Arbeitsplatte.

Basic model for all tops, unit made of finest quality natural wood, sliding shelf.

Länge length		Breite width		Höhe height		
mm	in.	mm	in.	mm	in.	
1030	40 ⁹ / ₁₆	540	21 ¹ / ₄	810	31 ⁷ / ₈	30.7900.0000

ELEGANCE

Digestifwagen rund, Liquor trolley round

Edelholzrahmen, Digestifaufsatz, ausziehbare Arbeitsplatte. Galerie auf Bodenplatte
 Unit made of finest quality natural wood, top for alcoholic beverages, sliding shelf.
 Gallery on the bottom shelf.

Höhe height		Ø-Außen Ø-outer		
mm	in.	mm	in.	
800	31½	620	24 ⁷ / ₁₆	30.7924.1020



ELEGANCE

Käsewagen rund, Cheese trolley round

Edelholzrahmen, Käseaufsatz, Schneidbrett aus Kunststoff Ø 450 mm drehbar,
 halbrollende Plexiglashaube, ausziehbare Arbeitsplatte. Galerie auf Bodenplatte
 Unit made of finest quality natural wood, top for cheese, plastic cutting board
 Ø 17¹/₁₆ inch revolving, with half roll top plexiglass hood, sliding shelf. Gallery on
 the bottom shelf.

Höhe height		Ø-Außen Ø-outer		
mm	in.	mm	in.	
800	31½	620	24 ⁷ / ₁₆	30.7924.1010



ELEGANCE

SERVIERWAGEN · SERVING TROLLEY

1 Käseaufsatz rund, Top for cheese round

Schneidbrett aus Kunststoff Ø 450 mm drehbar, halbrollende Plexiglashaube
Plastic cutting board Ø 17¹¹/₁₆ inch revolving, with half roll top plexiglass hood

Höhe height		Ø-Außen Ø-outer		
mm	in.	mm	in.	
300	11 ¹³ / ₁₆	530	20 ⁷ / ₈	30.7924.0010

1



2 Digestifaufsatz rund, Top for alcoholic beverages round

mit Galerie
with gallery

Höhe height		Ø-Außen Ø-outer		
mm	in.	mm	in.	
100	3 ¹⁵ / ₁₆	610	24	30.7924.0020

2



3 Aufsatz für Servierwagen, Top for serving trolley

Höhe height		Ø-Außen Ø-outer		
mm	in.	mm	in.	
20	1 ³ / ₁₆	610	24	30.7924.0030

3



4 Servierwagen rund, Serving trolley round

Grundmodell für alle Aufsätze, Edelholzrahmen, ausziehbare Arbeitsplatte.
Galerie auf Bodenplatte., Das Grundmodell ist nur mit Aufsatz verwendbar.
Basic model for all tops, unit made of finest quality natural wood, sliding shelf.
Gallery on the bottom shelf., The basic model can only be used with a top.

Höhe height		Ø-Außen Ø-outer		
mm	in.	mm	in.	
800	31 ¹ / ₂	620	24 ⁷ / ₁₆	30.7924.0000

4



ELEGANCE

1 Roomservicewagen, Room-Service-Trolley

Stabiles Vierkantröhr aus Edelstahl 18/10, kunststoffbeschichtete Tischplatte mit stabilen Scharnieren, abklappbar, Einschubscharnieren für Warmhaltebox
 Sturdy rectangular tube rack made of stainless steel 18/10, plastic laminated tabletop with stanble hinges, foldable, Slide-in rails for thermal box.

Seitenteile geklappt, 530 mm breit
 side-parts, 20⁷/₈ inch

Höhe height		Ø		
mm	in.	mm	in.	
770	30 ⁵ / ₁₆	1100	43 ⁵ / ₁₆	30.7930.0000



1

2 Warmhaltebox, Thermal Box

für Teller Ø 28 cm, aus Edelstahl 18/10, Innenraum mit 2 Ablagen,
 elektrisch aufheizbar bis max 80°

for plate Ø 11 inch, made of stainless steel 18/10, interior with 2 shelves.
 The thermal box can be heated electrically to a maximum of 176° F

Nennleistung 250 W, Sicherung 16A
 Power Supply 250 W, Fuse 16A

Länge length		Breite width		Höhe height		Netzspannung line voltage		
mm	in.	mm	in.	mm	in.	Volt		
340	13 ³ / ₈	340	13 ³ / ₈	400	15 ³ / ₄	220/50Hz	18/10	30.7979.0010



2

SERVIERWAGEN · SERVING TROLLEY

Digestifwagen, Liquor trolley

Edelholzrahmen, Digestifaufsatz, ausziehbare Arbeitsplatte und Schublade.

Unit made of finest quality natural wood, top for alcoholic beverages, sliding shelf and drawer



Länge length		Breite width		Höhe height		30.8009.0000
mm	in.	mm	in.	mm	in.	
1010	39 ³ / ₄	530	20 ⁷ / ₈	1070	42 ¹ / ₈	

PROFILE

Digestifwagen, Liquor trolley

Edelholzrahmen, Digestifaufsatz mit Glashalter, ausziehbare Arbeitsplatte und Schublade.

Unit made of finest quality natural wood, top for alcoholic beverages with glass holder, sliding shelf and drawer.



Länge length		Breite width		Höhe height		30.8008.0000
mm	in.	mm	in.	mm	in.	
1010	39 ³ / ₄	530	20 ⁷ / ₈	1270	50	

PROFILE

Sorbetwagen, Sorbet trolley

Edelholzrahmen, Sorbetaufsatz, Digestifaufsatz, ausziehbare Arbeitsplatte und Schublade, ohne Sorbetbehälter

Unit made of finest quality natural wood, top for sorbets, top for alcoholic beverages, sliding shelf and drawer, without sorbet pots

Länge length		Breite width		Höhe height		
mm	in.	mm	in.	mm	in.	
1010	39 ³ / ₄	530	20 ⁷ / ₈	910	35 ¹³ / ₁₆	30.8003.0000



PROFILE

Humidorwagen, Cigar trolley

Edelholzrahmen, Digestifaufsatz mit Glashalter, 2 Zigarettenfächer mit Befeuchter und Hygrometer, abschließbar, ausziehbare Arbeitsplatte und Schublade.

Unit made of finest quality natural wood, top for alcoholic beverages with glass holder, 2 compartments for cigars with moistener and hygrometer, lockable, sliding shelf and drawer.

Länge length		Breite width		Höhe height		
mm	in.	mm	in.	mm	in.	
1010	39 ³ / ₄	530	20 ⁷ / ₈	1270	50	30.8027.0000



PROFILE

SERVIERWAGEN · SERVING TROLLEY

Kuchen- und Nachspeisewagen, Pastry and dessert trolley

Edelholzrahmen, Kühlaufsatz 18/10, mit 2 Kühlpellets, Plexiglashaube, ausziehbare Arbeitsplatte und Schublade.

Unit made of finest quality natural wood, top 18/10 for cooling with 2 cooling pellets, plexiglass hood, sliding shelf and drawer.



Länge length		Breite width		Höhe height		30.8002.0000
mm	in.	mm	in.	mm	in.	
1010	39 ³ / ₄	530	20 ⁷ / ₈	1110	43 ¹¹ / ₁₆	

PROFILE

Käsewagen, Cheese trolley

Edelholzrahmen, Käseaufsatz mit halbbrollender Plexiglashaube, Kunstmarmorplatte, ausziehbare Arbeitsplatte und Schublade.

Unit made of finest quality natural wood, top for cheese, with roll top plexiglass hood, artificial marble plate, sliding shelf and drawer.



Länge length		Breite width		Höhe height		30.8014.0000
mm	in.	mm	in.	mm	in.	
1010	39 ³ / ₄	530	20 ⁷ / ₈	1080	42 ¹ / ₈	

PROFILE

Meeresfrüchtewagen, Seafood trolley

Edelholzrahmen, Holzaufsatz mit Roheiswanne 18/10, ausziehbare Arbeitsplatte und Schublade

Unit made of finest quality natural wood, wooden top with container 18/10 for ice, sliding shelf and drawer.

Länge length		Breite width		Höhe height		30.8005.0000
mm	in.	mm	in.	mm	in.	
1010	39 ³ / ₄	530	20 ⁷ / ₈	940	37	



PROFILE

Induktionswagen, Induction trolley

Edelholzrahmen mit Induktionsherd, Flaschenhalter, ausziehbare Arbeitsplatte und Schublade

Unit made of finest quality natural wood, with induction stove, bottle holder, sliding shelf and drawer.

Länge length		Breite width		Höhe height		Netzspannung line voltage	30.8026.0000
mm	in.	mm	in.	mm	in.	Volt	
1010	39 ³ / ₄	530	20 ⁷ / ₈	840	33 ¹ / ₁₆	230	



PROFILE

SERVIERWAGEN · SERVING TROLLEY

Flambierwagen, Flambé trolley

Edelholzrahmen, mit Zündsicherung und Magnetzündung, Arbeitsfläche Kunstmarmorplatte, Flaschenhalter, ohne Gasflasche, propangasbeheizt, einflammig
Unit made of finest quality natural wood, with safety pilot and magneto ignition, artificial marble plate for working, bottle holder, without gas bottle, propane gas heating, 1 flame

Länge length		Breite width		Höhe height		
mm	in.	mm	in.	mm	in.	
1080	42 ¹ / ₂	530	20 ⁷ / ₈	840	33 ¹ / ₁₆	30.8013.0000



PROFILE

Rinderbrustwagen, Roast beef trolley

Edelholzrahmen, ganz rollende Haube 18/10, klappbare Abstellplatte, abnehmbare Halterung für Tranchierbesteck, elektrisch beheizt
Unit made of finest quality natural wood, full roll top cover 18/10, hinged side plate, removable holder for carving set, electric heating

Länge length		Breite width		Höhe height		Netzspannung line voltage	
mm	in.	mm	in.	mm	in.	Volt	
1090	42 ¹⁵ / ₁₆	620	24 ⁷ / ₁₆	1060	41 ³ / ₄	220	30.8007.0000
1090	42 ¹⁵ / ₁₆	620	24 ⁷ / ₁₆	1060	41 ³ / ₄	110	30.8007.1000



PROFILE

1 Digestifaufsatz mit Glashalter, Top for alcoholic beverages with glass holder

Länge length		Breite width		Höhe height		
mm	in.	mm	in.	mm	in.	
840	33 ¹ / ₁₆	480	18 ⁷ / ₈	445	17 ¹ / ₂	30.8008.0010

2 Digestifaufsatz, Top for alcoholic beverages

Länge length		Breite width		Höhe height		
mm	in.	mm	in.	mm	in.	
840	33 ¹ / ₁₆	480	18 ⁷ / ₈	245	9 ⁵ / ₈	30.8009.0010

3 Sorbetaufsatz, Top for sorbets

Länge length		Breite width		Höhe height		
mm	in.	mm	in.	mm	in.	
840	33 ¹ / ₁₆	480	18 ⁷ / ₈	90	3 ⁹ / ₁₆	30.8003.0010

4 Kühlaufsatz mit Plexiglashaube, Top for cooling with plexiglass hood

Länge length		Breite width		Höhe height		
mm	in.	mm	in.	mm	in.	
815	32 ¹ / ₁₆	460	18 ¹ / ₈	285	11 ¹ / ₄	30.8002.0010

5 Käseufsatz, Top for cheese

Länge length		Breite width		Höhe height		
mm	in.	mm	in.	mm	in.	
860	33 ⁷ / ₈	505	19 ⁷ / ₈	255	10 ¹ / ₁₆	30.8014.0010

6 Meeresfrüchteufsatz, Top for seafood

Länge length		Breite width		Höhe height		
mm	in.	mm	in.	mm	in.	
820	32 ⁵ / ₁₆	460	18 ¹ / ₈	115	4 ¹ / ₂	30.8005.0010

7 Servierwagen - Grundmodell, Serving trolley - basic model

Länge length		Breite width		Höhe height		
mm	in.	mm	in.	mm	in.	
1010	39 ³ / ₄	530	20 ⁷ / ₈	825	32 ¹ / ₂	30.8000.0000

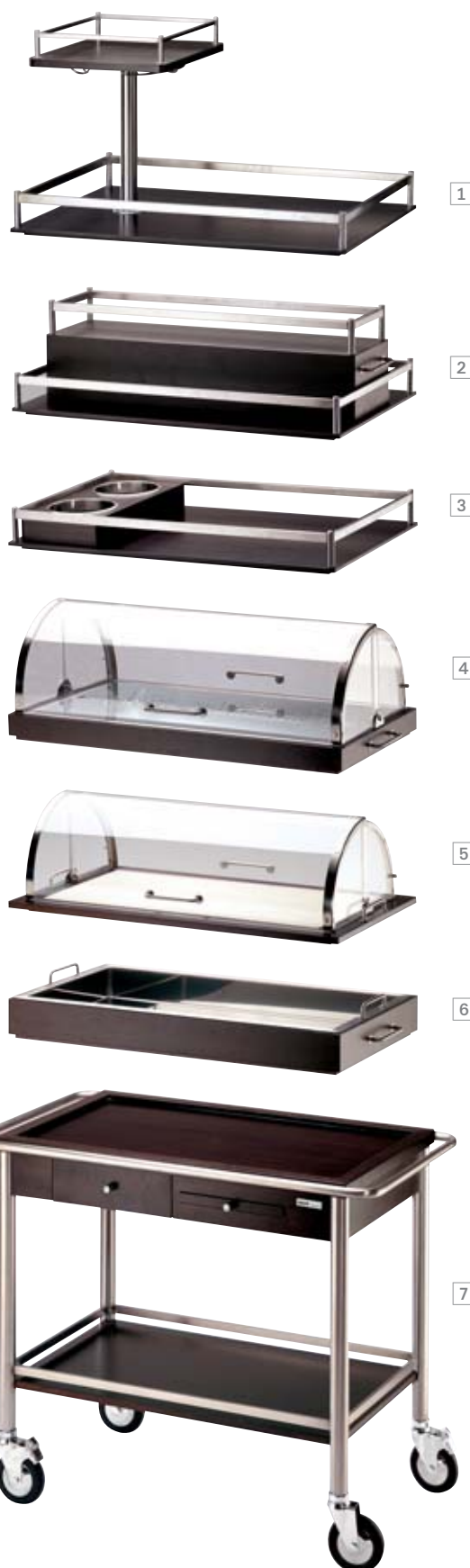

SERVIERWAGEN · SERVING TROLLEY

Digestifwagen rund, Liquor trolley round

Edelholzrahmen, Digestifaufsatz, ausziehbare Arbeitsplatte. Galerie auf Bodenplatte
Unit made of finest quality natural wood, top for alcoholic beverages, sliding shelf.
Gallery on the bottom shelf.



Höhe height		Ø-Außen Ø-outer		
mm	in.	mm	in.	
885	34 ¹³ / ₁₆	630	24 ¹³ / ₁₆	30.8024.1020

PROFILE

Käsewagen rund, Cheese trolley round

Edelholzrahmen, Käseaufsatz, Schneidbrett aus Kunststoff Ø 450 mm drehbar,
halbrollende Plexiglashaube, ausziehbare Arbeitsplatte. Galerie auf Bodenplatte
Unit made of finest quality natural wood, top for cheese, plastic cutting board
Ø 17¹¹/₁₆ inch revolving, with half roll top plexiglass hood, sliding shelf.
Gallery on the bottom shelf.



Höhe height		Ø-Außen Ø-outer		
mm	in.	mm	in.	
1060	41 ³ / ₄	630	24 ¹³ / ₁₆	30.8024.1010

PROFILE

1 Käseaufsatz rund, Top for cheese round

Schneidbrett aus Kunststoff Ø 450 mm drehbar, halbrollende Plexiglashaube
 Plastic cutting board Ø 17¹¹/₁₆ inch revolving, with half roll top plexiglass hood

Höhe height		Ø-Außen Ø-outer		
mm	in.	mm	in.	
280	11	610	24	30.8024.0010

2 Digestifaufsatz rund, Top for alcoholic beverages round

mit Galerie
 with gallery

Höhe height		Ø-Außen Ø-outer		
mm	in.	mm	in.	
105	4 ¹ / ₈	610	24	30.8024.0020



1

3 Aufsatz für Servierwagen, Top for serving trolley

mit Griffen
 with gripes

Höhe height		Ø-Außen Ø-outer		
mm	in.	mm	in.	
50	1 ¹⁵ / ₁₆	610	24	30.8024.0030



2

4 Servierwagen rund, Serving trolley round

Grundmodell für alle Aufsätze, Edelholzrahmen, ausziehbare Arbeitsplatte.
 Galerie auf Bodenplatte., Das Grundmodell ist nur mit Aufsatz verwendbar.
 Basic model for all tops, unit made of finest quality natural wood, sliding shelf.
 Gallery on the bottom shelf., The basic model can only be used with a top.

Höhe height		Ø-Außen Ø-outer		
mm	in.	mm	in.	
780	30 ¹¹ / ₁₆	630	24 ¹³ / ₁₆	30.8024.0000



3



4



Strahlende Optik durch die richtige Pflege

Wir möchten, dass Ihre Freude über den Kauf von HEPP Bestecken und Serviergeräten auf Dauer anhält. Bei der Herstellung wird darauf geachtet, dass die Produkte Ihrem Ambiente eine optimale Ausstrahlung verleihen. Auf den folgenden Seiten finden Sie wertvolle Informationen zur Pflege.



Brilliance with the right utensil care

We want you to enjoy your purchase of HEPP flatware and holloware for many years to come. That is why we made sure that our products will maximize the attractiveness of your restaurant. The following pages offer you valuable information on how to care for them.



PFLEGE · MAINTENANCE



PFLEGE · MAINTENANCE



Polieren von Platten, Schüsseln, Abdeckhauben, Eiskübel etc.
Polishing of platters, dishes, lids, ice buckets etc.



Messerklingschutz
Verhindert das Stumpfwerden der Klingen und poliert gefahrlos die Griffe.
* Benutzen Sie zum Polieren der Messer immer den Klingenschutz, da ansonsten das Förderband beschädigt werden könnte.

Knife blade protector
Prevents the blunting of knife blades and ensures that only the handles are polished.
* Always polish the knives in the knife holder as otherwise the conveyor belt could be damaged.



Abteilverrichtung
für runde Platten, Deckel, Schüsseln, Körbchen sowie Kännchen mit Deckeln.

Compartment section
for round platters, lids, dishes, baskets and coffee pots with lids.



Goliath 2000 Type C

75.9201.0010

Mit dieser Maschine werden Bestecke und Serviergeräte mühelos und ohne jegliche Abnutzung der Feinsilberauflage poliert. Bei jedem Poliervorgang wird die Auflage neu gehärtet und verdichtet. Es ergibt sich eine problemlose Grundreinigung, und die Lebensdauer der Feinsilberauflage wird wesentlich verlängert. Durch ein offenes Trogsystem kann die Maschine bei laufendem Poliervorgang bestückt bzw. das Poliergut entnommen werden.

Die kompakte Bauweise mit ihrer 56 cm-Frontbreite findet in jeder Küche Platz. Die Steuerelemente sind komplett versenkt und ergonomisch im 40°-Winkel angeordnet.

- Ein Poliervorgang ca. 3 Minuten
- Fassungsvermögen ca. 30 Besteckteile, sortiert in Löffel oder Gabeln, Messer nur mit Messerpoliervorrichtung. Serviergeräte wie z.B. Saucieren, Schüsseln, Weinkühler und Platten bis 30 cm Ø oder 30 x 42 cm.
- Polieren ohne Abteilverrichtung: z.B. 1 Weinkühler
- Polieren mit Abteilverrichtung: z.B. 3 Platzteller

Bitte beachten Sie die gesonderte Betriebsanleitung des Herstellers für die Maschine.

Standardmäßig ausgerüstet mit einem Sammel-Drehkorb. Die Bestecke werden beim Entnehmen sofort von den Polierkugeln getrennt. Dadurch Verdreifachung der Polierkapazität. Die Bandgeschwindigkeit ist wählbar zwischen Normalgeschwindigkeit für Dauerbetrieb sowie langsame Drehzahl für das Positionieren des Sammelkorbes oder das Polieren von großen Teilen.

Für die periodische Reinigung lässt sich die gesamte horizontale Verschalung von der Maschine in einem Handgriff ohne Werkzeug entfernen. Dadurch lässt sich die Außenwanne jederzeit ausspülen, ohne dass die Polierkugeln entfernt werden müssen, und die Maschine bietet im Bedarfsfall sofortigen Zugang zur Steuerung oder zum Antrieb. Ein Sicherheitsschalter unterbricht den Stromkreislauf sofort, sobald die Abdeckung entfernt wird. Die Kraftübertragung per Keilriemen ist zuverlässig, sparsam im Stromverbrauch und sehr unterhaltsfreundlich (kein Getriebe = keine periodische Schmierung!).

Technische Daten

Bandgeschwindigkeit:	einstellbar 40 cm oder 20 cm/sec.
Größe Poliertrog:	Ø 31 x 43 cm
Chassis in Edelstahl:	fahrbar mit Radstopper
Gehäuse:	Chromnickelstahl mattiert
Steuerung:	Kombischalter 1-0-30 Min. Schaltuhr, Wahlschalter für Geschwindigkeit
Anschlusswert:	3 x 400 V~max. 330 W, 50 oder 60 Hz
Ablaufhahn:	Ø 1" (Nennwert 25 mm)
Abmessungen:	560 x 715 x 900 mm
Gewicht:	83 kg + 70 kg Polierstahlkugeln
Zubehör:	70 kg Polierstahlkugeln, 1 Abteilverrichtung (teilt den Poliertrog in drei Fächer) 5 Messerklingenschutz (schützen die Klinge beim Polieren) inkl. Halter 1 Sammel-Korb Typ 20 (17 x 17 mm Maschenweite)

Technische Änderungen und Verbesserungen vorbehalten

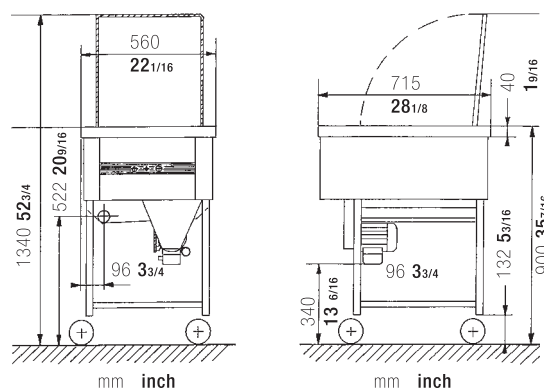

POLIERMASCHINE · BURNISHING MACHINE

Goliath 2000 Type C

75.9201.0010

The machine is used to polish cutlery and serving equipment without damaging the fine silver plating. The plating is rehardened and compacted during every polishing. This results in a problemfree basic cleaning and the service life of the fine silver plating is significantly prolonged. Thanks to an open trough system the machine can be filled and emptied with cutlery, etc., during polishing.

The compact design, with a front width of just $22\frac{1}{16}$ inch, means that it can fit into any kitchen. The control switches are fully recessed and arranged ergonomically at an angle of 40° .

- Polishing takes approx. 3 minutes
- Capacity approx. 30 pieces of cutlery, sorted as spoons or forks, knives only with knife polishing devices.
Serving equipment such as gravy boats, dishes, wine coolers and trays up to $11\frac{13}{16}$ inch \varnothing or $11\frac{13}{16}$ x $16\frac{9}{16}$ inch.
Polishing without compartmenting device: e.g. 1 wine cooler
Polishing with compartmenting device: e.g. 3 service plates

Please pay attention to the operating instructions provided by the machine's manufacturer.

Standard equipment includes a rotary basket. The cutlery is immediately separated from the polishing balls on removal of this basket. This triples the polishing capacity.

The belt has two speeds. The standard speed is for normal operation and the reduced speed for positioning the basket or polishing larger items.

The entire horizontal casing can be easily removed from the machine without tools for periodic cleaning. The outer tank can thus be rinsed at any time without having to remove the polishing balls. The machine also offers immediate access to the electrical controls and drive components as required. A safety switch immediately interrupts the power supply as soon as the casing is removed. The power transmission via the V-belt is reliable, economical and requires little or no maintenance (no gears = no periodic lubrication!).

Technical data

Belt speed:	adjustable $15\frac{3}{4}$ inch or $7\frac{7}{8}$ inch/sec
Size of polishing trough:	\varnothing $12\frac{3}{16}$ x $16\frac{15}{16}$ inch
*Chassis:	movable with wheel brake
Casing:	stainless steel (mat)
Control system:	Combi-switch 1-0-30 minute timer, 2-speed switch
Connected load:	3 x 400 V~max. 330 W, 50 or 60 cycles
Drainage tap:	\varnothing 1" (nominal value 1 inch)
Dimensions:	$22\frac{1}{16}$ x $28\frac{1}{8}$ x $35\frac{7}{16}$ inch;
Weight:	2669 oz + 2251 oz polishing steel balls
Accessories:	2251 oz polishing steel balls 1 compartmenting device (divides polishing through into 3 compartments) 5 knife blade protectors (protect blades during polishing) including holder, 1 Type 20 sorting basket ($1\frac{1}{16}$ x $1\frac{1}{16}$ inch mesh width)

Subject to technical changes and improvements

*= stainless steel

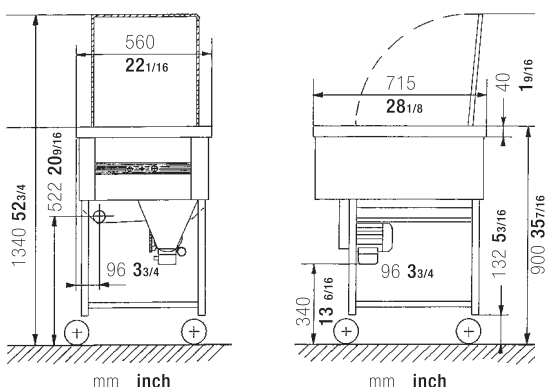

Goliath 2000 Type B

75.9200.0000

Mit dieser Maschine werden Bestecke und Serviergeräte mühelos und ohne jegliche Abnutzung der Feinsilberauflage poliert. Bei jedem Poliervorgang wird die Auflage neu gehärtet und verdichtet. Es ergibt sich eine problemlose Grundreinigung, und die Lebensdauer der Feinsilberauflage wird wesentlich verlängert. Durch ein offenes Trogsystem kann die Maschine bei laufendem Poliervorgang bestückt bzw. das Poliergut entnommen werden.

- Ein Poliervorgang ca. 3 Minuten
- Fassungsvermögen ca. 30 Besteckteile, sortiert in Löffel oder Gabeln, Messer nur mit Messerpoliervorrichtung.
Serviergeräte wie z.B. Saucieren, Schüsseln, Weinkühler und Platten bis 30 cm Ø oder 30 x 42 cm.
Polieren ohne Abteilverrichtung: z.B. 1 Weinkühler
Polieren mit Abteilverrichtung: z.B. 3 Platzteller

Bitte beachten Sie die gesonderte Betriebsanleitung des Herstellers für die Maschine.

Für die periodische Reinigung lässt sich die gesamte horizontale Verschaltung von der Maschine in einem Handgriff ohne Werkzeug entfernen. Dadurch lässt sich die Außenwanne jederzeit ausspülen, ohne dass die Polierkugeln entfernt werden müssen, und die Maschine bietet im Bedarfsfall sofortigen Zugang zur Steuerung oder zum Antrieb. Ein Sicherheitsschalter unterbricht den Stromkreislauf sofort, sobald die Abdeckung entfernt wird. Die Kraftübertragung per Keilriemen ist zuverlässig, sparsam im Stromverbrauch und sehr unterhaltsfreundlich (kein Getriebe = keine periodische Schmierung!). Goliath 2000 Type B hat eine konstante Drehzahl und ist mit einem Einphasen- Motor ausgerüstet.

Technische Daten

Bandgeschwindigkeit:	konstant 40 cm/sec
Größe Poliertrog:	Ø 31 x 43 cm
Chassis in Edelstahl:	fahrbar mit Radstopper
Gehäuse:	Chromnickelstahl gebürstet
Steuerung:	Kombischalter 1-0-30 Min. Schaltuhr, oder non stop
Anschlusswert:	1 x 230/240 V-max. 330 W, 50 oder 60 Hz
Ablaufhahn:	Ø 1" (Nennwert 25 mm)
Gewicht:	81 kg + 70 kg Polierstahlkugeln
Zubehör:	70 kg Polierstahlkugeln, 1 Abteilverrichtung (teilt den Poliertrog in drei Fächer) 5 Messerklingenschutz (schützen die Klinge beim Polieren)

Technische Änderungen und Verbesserungen vorbehalten

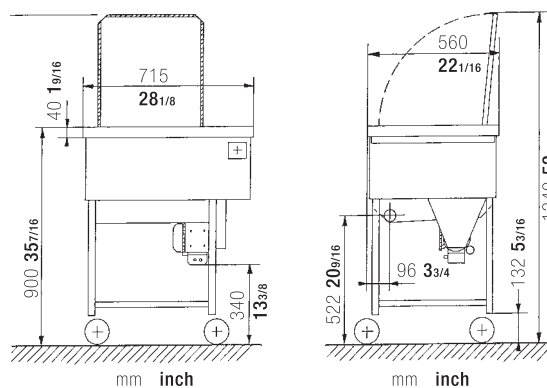

POLIERMASCHINE · BURNISHING MACHINE

Goliath 2000 Type B

75.9200.0000

The machine is used to polish cutlery and serving equipment without damaging the fine silver plating. The plating is rehardened and compacted during every polishing. This results in a problemfree basic cleaning and the service life of the fine silver plating is significantly prolonged. Thanks to an open through system the machine can be filled and emptied with cutlery, etc., during polishing.

- Polishing takes approx. 3 minutes
- Capacity approx. 30 pieces of cutlery, sorted as spoons or forks, knives only with knife polishing devices.
Serving equipment such as gravy boats, dishes, wine coolers and trays up to 11¹³/₁₆ inch Ø or 11¹³/₁₆ x 16⁹/₁₆ inch.
Polishing without compartmenting device: e.g. 1 wine cooler
Polishing with compartmenting device: e.g. 3 service plates

Please pay attention to the operating instructions provided by the machine's manufacturer.

The entire horizontal casing can be easily removed from the machine without tools for periodic cleaning. The outer tank can thus be rinsed at any time without having to remove the polishing balls. The machine also offers immediate access to the electrical controls and drive components as required. A safety switch immediately interrupts the power supply as soon as the casing is removed. The power transmission via the V-belt is reliable, economical and requires little or no maintenance (no gears = no periodic lubrication!).

Goliath 2000 Type B runs at a constant speed and is equipped with a single-phase motor.

Technical data

Belt speed:	constant 15 ³ / ₄ inch/sec
Size of polishing trough:	Ø 12 ³ / ₁₆ x 16 ¹⁵ / ₁₆ inch
Chassis:	Stainless steel mobile with wheel- stoppers
Casing:	Stainless steel (mat)
Controls:	Combi- switch for 30 minutes or non- stop
Electrical data:	1 x 230/240 V-330 W, 50 or 60 cycles
Drainage tap:	Ø 1" (nominal value 1 inch)
Weight:	approx. 2604 oz machine+ 2251 oz polishing balls
Accessories:	2604 oz polishing steel balls, 1 compartmentingdevice (divides polishing trough into 3 compartments) 5 knife blade protectors (protect blades during polishing)

Subject to technical changes and improvements

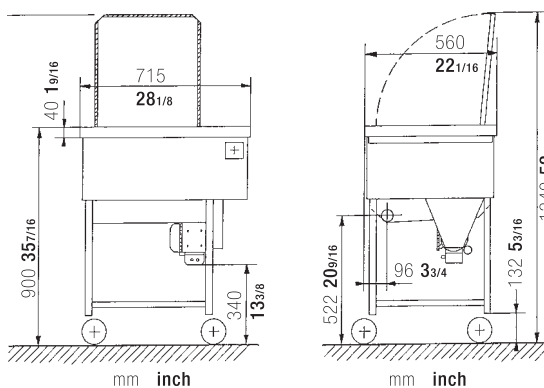

RAYMOR-POLISH

Seifenpulver für Silberpoliermaschine Goliath 2000, vermeidet Rückstände, schont Maschine und Förderband.

Soap powder for Silver Burnishing Machine Goliath 2000. Prevents formation of residues, treats machine and conveyor belt carefully.

Inhalt
cap.

Ltr.	oz.	
8,00 kg	257	75.9205.0000



NEUTRAL

Reinigungspaste für Silber, Silver polish

6 Dosen à 750 Gramm

6 tins 24 oz each

Inhalt
cap.

Ltr.	oz.	
750 Gramm	24	75.9223.0000



NEUTRAL

HEPP-Silberrein

Das traditionelle und schnellwirkende Reinigungsmittel für Hotelsilber.

The efficient and quick-acting cleaner for silver items.

Inhalt
cap.

Ltr.	oz.	
5,00 kg	161	75.9209.0000



NEUTRAL

PFLEGE · MAINTENANCE



HEPPOLIT-Silberreinigungspulver, HEPPOLIT-Silver cleaning powder

nur wirksam in Verbindung mit HEPP-Silberreinigungsapparat oder HEPP-Silberreinigungsplatten. 1 Esslöffel HEPPOLIT in 1 Liter heißem Wasser auflösen, Silbergegenstände 2 Minuten in dieser Lauge liegen lassen, spülen.

effective only in combination with the HEPP Silver Cleaning Apparatus or HEPP Silver Cleaning Plates. Dissolve 1 table spoon of HEPPOLIT in 1 litre of hot water, leave silver articles for 2 minutes in this solution, rinse

Inhalt
cap.

Ltr.	oz.
5,00 kg	161

75.9211.0000

NEUTRAL

HEPP-Silberreinigungsapparat, HEPP-Silver cleaning apparatus

mit Aluminium-Einsatz, das ideale Gerät für einfache Silberpflege. Silbergegenstände trocken einlegen, heißes Wasser mit je 1 Esslöffel HEPPOLIT Reinigungspulver pro Liter hinzugeben, Silbergegenstände 2 Minuten liegen lassen, herausnehmen, nachspülen, nach Silberreinigung Aluminium-Einsatz vom Schmutz befreien.

with aluminum insert - the ideal appliance for simple silver care. Put in silver articles dry, add hot water together with 1 table spoon of HEPPOLIT Cleaning Powder for each litre. Leave silver articles in this solution for 2 minutes, then take them out and rinse. After silver cleaning remove dirt from aluminium insert.



Inhalt cap.	Länge length	Breite width	Höhe height	Aluminium aluminium	Zink und Aluminium zinc coated and aluminium
Ltr. oz.	mm in.	mm in.	mm in.		
1 55,0 1937	633 24 ¹⁵ / ₁₆	428 16 ⁷ / ₈	224 8 ¹³ / ₁₆		75.9207.0000
2 55,0 1937	620 24 ⁷ / ₁₆	400 15 ³ / ₄	200 7 ⁷ / ₈	75.9208.0000	

NEUTRAL

HEPP-Silberreinigungsplatten, HEPP-Silver cleaning plates

aus Aluminium, empfehlenswert für Hepp-Silberreinigungsapparat. Kann auch in Kunststoffbecken eingelegt werden.

of aluminum, recommendable for Hepp Silver Cleaning Apparatus. Can also be put into plastic basins.

Inhalt
cap.

1 Packung mit 10 Platten	1 package with 10 plates
--------------------------	--------------------------

Aluminium
aluminium

75.9210.0000



NEUTRAL

WEITERE SORTIMENTE MORE ASSORTMENTS

Hospitala

Der Bereich Hospitala von HEPP bietet für das Care- und Businesscatering Systemgeschirrtelle und Bestecke. Die Speisenverteilungssysteme und Produkte sind für zeitgemäßes Küchen- und Verpflegungsmanagement entwickelt: Vorbildlich in Qualität, Funktionalität und Design.

HEPP Hospitala offers tableware and cutlery for care- and businesscatering, the food distribution systems and products are made for contemporary kitchen- and catering management: quality, functionality and design in an exemplary matter.



Airline Inflight

HEPP stattet namhafte Airlines mit Equipment für die Bordverpflegung aus. Die hochwertigen Qualitätsprodukte sind ganz auf die Bedürfnisse der Bewirtung in Flugzeugen angepasst und unterstreichen durch innovative Lösungen die kulinarische Kompetenz an Bord.

HEPP provides well-known airlines with equipment for catering. The highclass quality products are customized for the needs of catering in airplanes. They emphasize the culinary competence on board with innovative solutions.



HEPP – Ihr Spezialist für:

- Hotelbestecke
- Hotelserviergeräte
- Speisenverteilssysteme
- Airlines-Inflight Artikel

HEPP – special company for:

- hotel flatware
- hotel hollowware
- food distribution systems
- airlines inflight items

Für **weitere Informationen** stehen Ihnen Ihre HEPP Vertriebspartner gerne zur Verfügung.
Your HEPP sales partners are always available to give you **more information**.



HEPP

Gebrüder HEPP

Carl-Benz-Straße 10 · D-75217 Birkenfeld (Germany)
Telefon: +49 72 31 4 88 50 · Telefax: +49 72 31 48 85 44
info@hepp.de · www.hepp.de

Druckfehler und Irrtum für den gesamten Inhalt vorbehalten.
The entire content is subject to misprints and errors.